

CREATIVE LABS, INC.

SOUND BLASTER

SPEECH/MUSIC/VOICE/MIDI/GAME PORT

THE ULTIMATE SOUND BOARD FOR YOUR PC

BLAST AWAY THE PC SOUND BARRIER

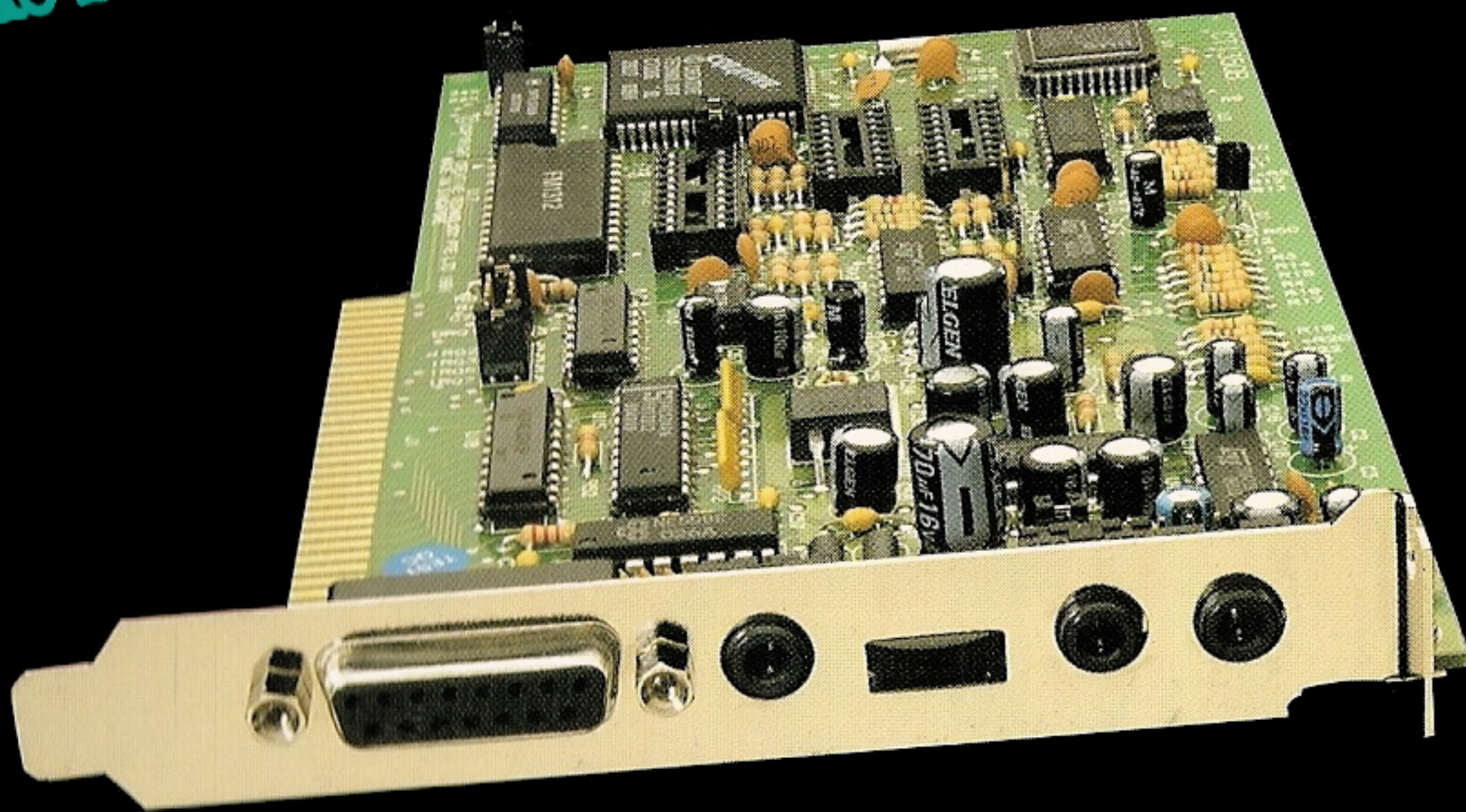

THE ALL-IN-ONE SOUND CARD

with all the great features you dreamt of . . .

**USER
REFERENCE
MANUAL**

SOUND BLASTER

R E F E R E N C E M A N U A L



Copyright © Creative Labs, Inc., 1989-1991
Copyright © Creative Technology Pte Ltd., 1989-1991

Software License Notice

This manual and software described in it are copyrighted internationally with all rights reserved. Under the copyright laws, this manual or the software may not be copied, in whole or part without written consent of **Creative Labs, Inc.**, except in the normal use of the software or to make a backup copy of the software. The same proprietary and copyright notices must be affixed to any permitted copies as were affixed to the original. This exception does not allow copies to be made for others, whether or not sold, but all of the material purchased (with all backup copies) may be sold, given, or loaned to another person. Under the law, copying includes translating into another language or format. You may use the software on any computer owned by you, but extra copies cannot be made for this purpose.

WARRANTY

Creative Labs, Inc. warrants the physical diskette and documentation to be free of defects in workmanship for a period of 60 days from the date of purchase. In the event of a defect in material or workmanship during the warranty period, Creative Labs will replace the defective diskette or documentation when the defective product is returned to Creative Labs, Inc. by the owner. The remedy for this breach of warranty is limited to replacement only and shall not cover any other damages, including but not limited to the loss of profit, special, incidental, consequential and other similar claims.

Creative Labs, Inc. specifically disclaims all other warranties, expressed or implied, including but not limited to implied warranties of merchant ability and fitness for a particular purpose with respect to the defects of the products and program license granted herein. With respect to the use of this product, in no event shall Creative Labs, Inc. be liable for any loss of profit or any other commercial damage, including but not limited to special, incidental, consequential or other damages.

SOUND BLASTER

FCC NOTICE

This card has been tested and found to comply with the limits for a Class B digital device, pursuant to of Part 15 of the FCC Rules. These limits are designed to provide reasonable protected against harmful interference in a residential installation. This equipment generates, uses, and can radiate radio frequency energy and, if not installed and used in accordance with the instruction, may cause harmful interference to radio communications. However, there is no guarantee that interference will not occur in a particular installation. If this equipment does cause harmful interference to radio or television reception, which can be determined by turning the equipment off and on, the user is encourage to try to correct the interference by one or more of the following measures:

Reorient or relocate the receiving antenna.

Increase the separation between the equipment and receiver.

Connect the equipment into an outlet on a circuit different from that to which the receiver is connected.

Consult the dealer or an experience radio/ TV technician for help.

CAUTION

To comply with the limits for the Class B digital device, pursuant to Part 15 of the FCC Rules, this card must be installed in computer equipmentscertified to comply with the Class B limits. All cables used to connect the computer and peripherals must be shielded and grounded. Operation with non-certified computers or non-shielded cables may result in interference to radio or television reception.

MODIFICATION

Any changes or modofications not expressly approved by the grantee of this device could void the user's authority to operate the equipment.

Creative Labs, Inc.

2050 Duane Avenue Santa Clara CA 95054

USA Technical Support Line: **(408) 982 9226**



Contents

Chapter 1	INSTALLATION	1-1
Chapter 2	VOICE UTILITIES	2-1
Chapter 3	SBTALKER TEXT-TO-SPEECH SYNTHESIZER	3-1
Chapter 4	THE TALKING PARROT	4-1
Chapter 5	FM INTELLIGENT ORGAN	5-1
Chapter 6	WINDOWS 3.0 APPLICATIONS	6-1
APPENDIX	APPENDIX A	A-3
	APPENDIX B	A-5
	APPENDIX C	A-6
	APPENDIX D	A-13

Introduction to Sound Blaster

Sound Blaster converts your PC into a super entertainment and educational machine. It takes the lead by offering you an all-in-one solution for your PC sound needs. Orchestra-like music, special effects, real human voices or any kind of sound can be easily reproduced with Sound Blaster .

Sound Blaster has all the great features that has made it the leading sound card. These includes a fully Ad Lib compatible 11-voice FM music synthesizer, digitized voice channel, voice input (sampling) channel, MIDI interface and joystick port all built into one fabulous sound board. The bundled software: FM Intelligent Organ, Voice Utilities, Talking Parrot, Text-to-speech, and Windows 3.0 DLL (Dynamic Link Library) provide additional value to the package.

Sound Blaster offers both a microphone input jack and a line-in jack to let you record or digitize any kind of sound from a multitude of sources. The built-in microphone amplifier has increased sensitivity so you can talk naturally into the microphone. The DMA technology and proprietary hardware decompression algorithm enhances its performance by conserving precious hard disk space, memory and CPU time. We have increased the digitized voice recording (ADC) sampling rate from 12KHz to 15KHz and the digitized voice playback (DAC) sampling rate from 23KHz to 44.1KHz.

The stereo power amplifier can drive any speakers or headset directly. We even provide you with a pair of stereo cables in case you want to connect to your home stereo system. There is also a handy volume control knob on the card.

Finally, to fulfil the wishes of many users, Sound Blaster comes with a standard joystick port and built-in MIDI interface. The MIDI interface is designed into the joystick port saving a much needed slot on the PC.

For those serious about MIDI, connecting to a MIDI instrument requires our optional MIDI Kit which includes software and the MIDI adaptor cable. The MIDI adaptor also has a joystick port so you can continue to use the joystick. The MIDI Kit offers high value and a low price tag. Sound Blaster already has the largest collection of supporting software from **Day One** and this collection is growing rapidly.

Thank you for your purchase of Sound Blaster. We are sure that you will enjoy it for many years to come.

INSTALLATION

Installation	1-3
Before You Start	1-3
System Requirements	1-3
Calling Technical Support	1-4
Before Calling	1-4
Unpacking	1-4
Backup Copies	1-5
Sound Blaster Card Installation	1-5
Jumper Locations and Settings	1-6
Testing Installation	1-7
Changing Hardware Setting	1-8
I/O Address	1-8
Interrupt Line	1-8
DMA Channel	1-9
Connecting Devices	1-9
Joystick/MIDI Port	1-9
MIDI Kit	1-10
Software Installation	1-11
Setting the Sound Environment	1-11
Set Sound	1-11
Set Blaster	1-12
Installation Sound Drivers	1-12
Changing Blaster Settings	1-12
Third Party Software	1-13

SOUND BLASTER

INSTALLATION

Before You Start

Although you are anxious to start using your new Sound Blaster Card as soon as possible, take a few minutes to read these first few pages to prevent problems from arising due to software or hardware conflicts. Also, once you have installed the software, you may want to check the **Readme** file on the diskette labeled **Sound Blaster #1** for any last minute changes or corrections not contained in this manual. Type **README** to view the Readme file.

Important: This manual assumes a certain degree of computer knowledge and understanding of DOS. Refer to your DOS manual for instructions in making backup copies, making or changing to different directories and other operations.

System Requirements

- ▶ IBM PC XT, AT, 286 compatibles and above. PS/2 Model 25 and 30. Tandy compatibles (except 1000EX/HX).
- ▶ Minimum Two Disk Drive System (Hard Disk Recommended)
- ▶ 640K RAM
- ▶ CGA, EGA or VGA monitor

Calling Technical Support

We hope that you don't have an occasion to call us, but at Creative Labs we are committed to giving our customers the best products possible as well as excellent technical support. If the need should arise, you can reach technical assistance by calling our USA technical support line at **(408) 9829226**.

Before Calling

- ▶ Make a note of any unresolved IRQ, DMA and I/O conflicts.
- ▶ Check that external connections to the Sound Blaster card are correct.
- ▶ Check that the manual volume control is set to midrange.
- ▶ If the software you are using has a sound on/off switch, make sure it is set to on.
- ▶ If a problem persists, write down exactly what occurred. This should include the name and version of the software used, computer configuration, and the exact nature of the problem. Have this information ready when you call technical support. Or, if you write us, include this information in your letter or FAX.

Feel free to write us with any questions, concerns or suggestions. Numerous bulletin boards provide Sound Blaster support. Also available from Creative Labs are Sound Blaster's Developer Kits for both DOS and Windows 3.0.

Backup Copies

It is always a good and safe idea to make a backup copy of your original software. If you have not done so, make a backup copy of your Sound Blaster diskettes before beginning installation. Store your original diskettes in a safe place.

Sound Blaster Card Installation

Installing the Sound Blaster Card in your computer is simple and easy. However, please read and follow the instructions carefully before beginning the installation process.

SOUND BLASTER

1. Turn the computer **OFF**.
2. If you have a card with a joystick port already installed, either remove it, or disable the Sound Blaster's joystick port by removing jumper **JP8** on the Sound Blaster card (See **Figure 1**).
3. Open the computer and install the card into any free slot .
4. Close up the computer .
5. Turn on the computer.
6. Adjust volume control on card to mid range.
7. Plug in speakers or headphones

Warning: The built-in stereo power amplifier has a maximum output of four watts per channel with four ohms speakers and two watts per channel with eight ohms speakers. Do **NOT** play at maximum volume if your speaker can not handle this power.

Jumper Locations and Settings

The following drawing shows the locations and default jumper settings for I/O address, DMA channel and IRQ interrupt.

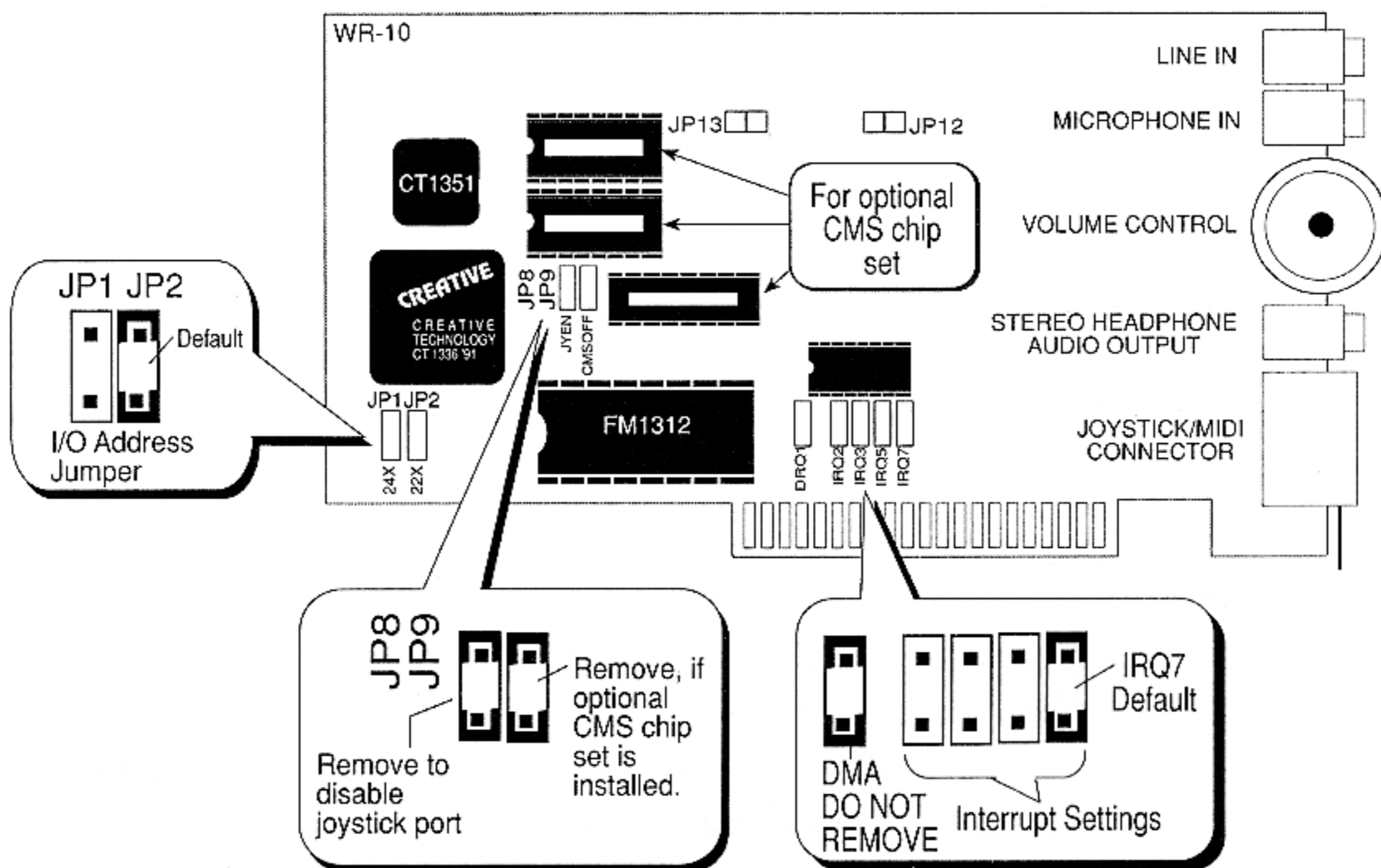

Figure 1

Testing Installation

The diagnostic program for Sound Blaster card, **TEST-SBC**, is found on the diskette labeled **Sound Blaster Disk #1**. This program tests Sound Blaster's basic hardware configuration for base I/O address, interrupt and DMA channel. These settings are jumper selectable. (Refer to **Figure 1** for details).

The program scans the jumper setting to identify the current hardware configuration. Once identified, a menu display lets you test the voice and music output. The automatic scanning process lets you install the card easily by scanning for the factory defaults and then checking whether the default settings have been changed.

To test installation and configuration:

1. Insert **Sound Blaster Disk # 1** into drive A and type **TEST-SBC** and press **Enter**.
2. Follow instructions on the screen

You can also add the **/M** switch to manually enter setting. Example: **TEST-SBC /M**.

When using the **/M** switch, the program will prompt you to select a possible hardware configuration that matches the card's jumper settings. If the test program reports an error on one of the settings, this indicates a hardware conflict between Sound Blaster and another hardware card.

To resolve hardware conflicts, you need to change the hardware configuration on either the adaptor card or the Sound Blaster card. We strongly suggest, however, that you avoid changing the factory default setting on the Sound Blaster card since it is downward compatible with previous Sound Blaster software.

If you do decide to change the hardware configuration on the Sound Blaster card, please refer to **Figure 1** and **Appendix C**, to solve any installation problem. Changing the factory default configuration requires installation or reinstallation of sound drivers. Refer to **Setting the Sound Environment** and **Installing Sound Drivers**.

SOUND BLASTER

Note: There are times when the automatic scanning of hardware configuration process might not work due to possible hardware conflicts with other adaptor cards in your system. On occasion, other adaptor cards may use the I/O port, interrupt or DMA channel accessed by the test program.

Changing Hardware Settings

For those who wish to change setting, switch off the computer and remove the Sound Blaster card from the computer. Locate the jumpers by referring to **Figure 1**.

I/O Address

Only two I/O addresses are selectable: 220Hex and 240Hex. Place the jumper on the selected pins.

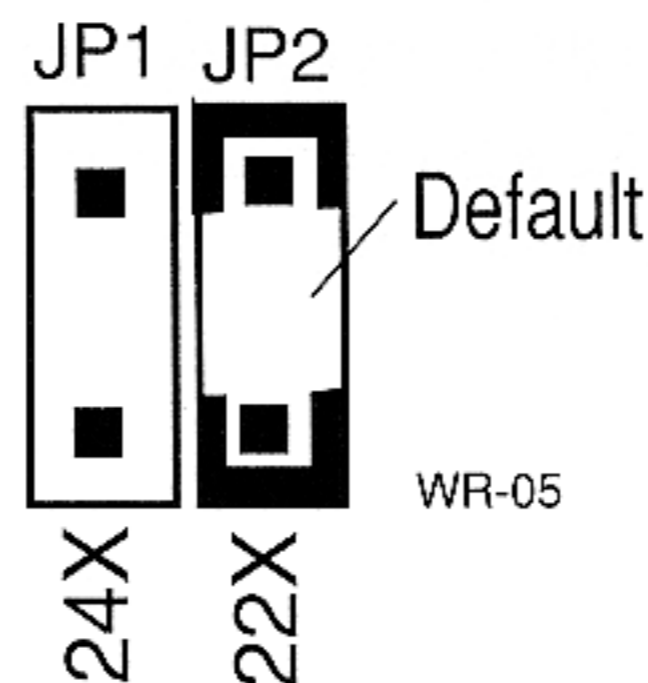

I/O Address Jumper

Interrupt Line

Four possible interrupt lines are available. Place the jumper on the desired Interrupt Line pins.

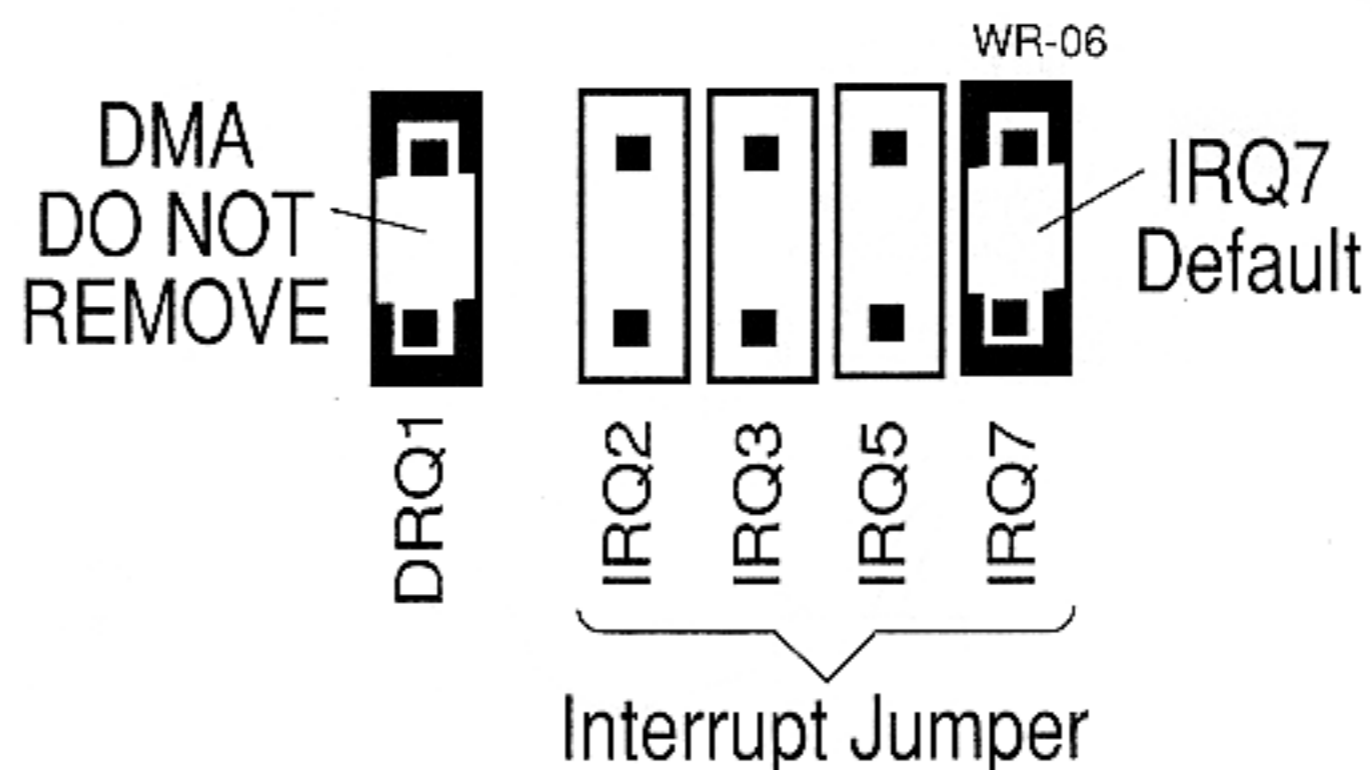

SOUND BLASTER

DMA Channel

You can not change the DMA channel. The jumper on the DMA channel is required to operate the Sound Blaster; do **NOT** remove it.

Connecting Devices

Connecting speakers, microphone, joystick and line-in devices are simple (refer to the diagram). However, there are a few simple rules you need to follow:

- ▶ Make sure devices are plugged into the correct jack.
- ▶ Do not plug in a microphone and line-in device at the same time. Doing so will not damage your card, but it substantially decreases the input signal to the card.
- ▶ Do not set volume to maximum if your speakers cannot handle the power output of the Sound Blaster. The Sound Blaster generates four watts with four ohm speakers and two watts with eight ohm speakers.
- ▶ Use a good quality microphone. Generally, a microphone costing around US\$30.00 is suitable. A condenser microphone also works well.

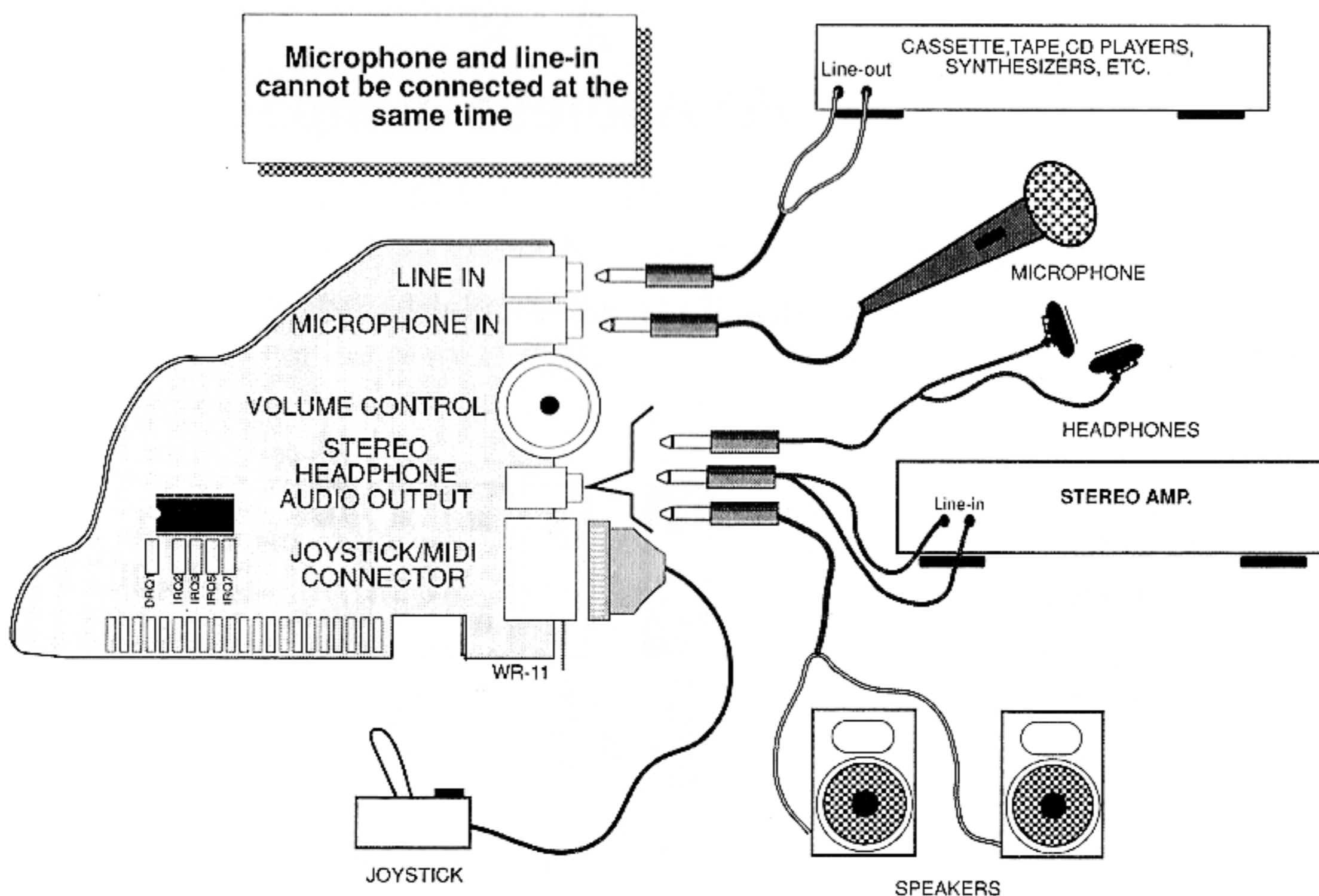

Joystick/MIDI Port

The joystick port on the Sound Blaster is identical to that on the standard PC game control adaptor or game I/O port. The port can connect any analog joystick with a 15-pin D-Sub connector and support all standard PC joystick compatible software. Remember, if your PC already has a game card or port, either remove it or disable the game port on the Sound Blaster card by removing jumper **JP8** (See **Figure 1**). Disabling the joystick port does not affect its use as a MIDI port.

If you need to run two joysticks, a joystick splitter Y-cable is available from Creative Labs. (Refer to the Software and Hardware catalog included with your Sound Blaster.)

MIDI Kit

The dual joystick port and MIDI port takes up only one slot in your PC leaving room for other cards. To access the MIDI function requires the optional MIDI Kit. The MIDI Kits contains a MIDI adaptor with a joystick port so you can use both a joystick and a MIDI instrument.

MIDI Kit alone does not complete the list for a MIDI setup. You still need software. The FM Intelligent Organ, bundled with this package, support the MIDI keyboard. You can play the computer keyboard as well as the MIDI keyboard. Please ask your dealer or call Creative Labs for the latest updates on MIDI software available for the Sound Blaster.

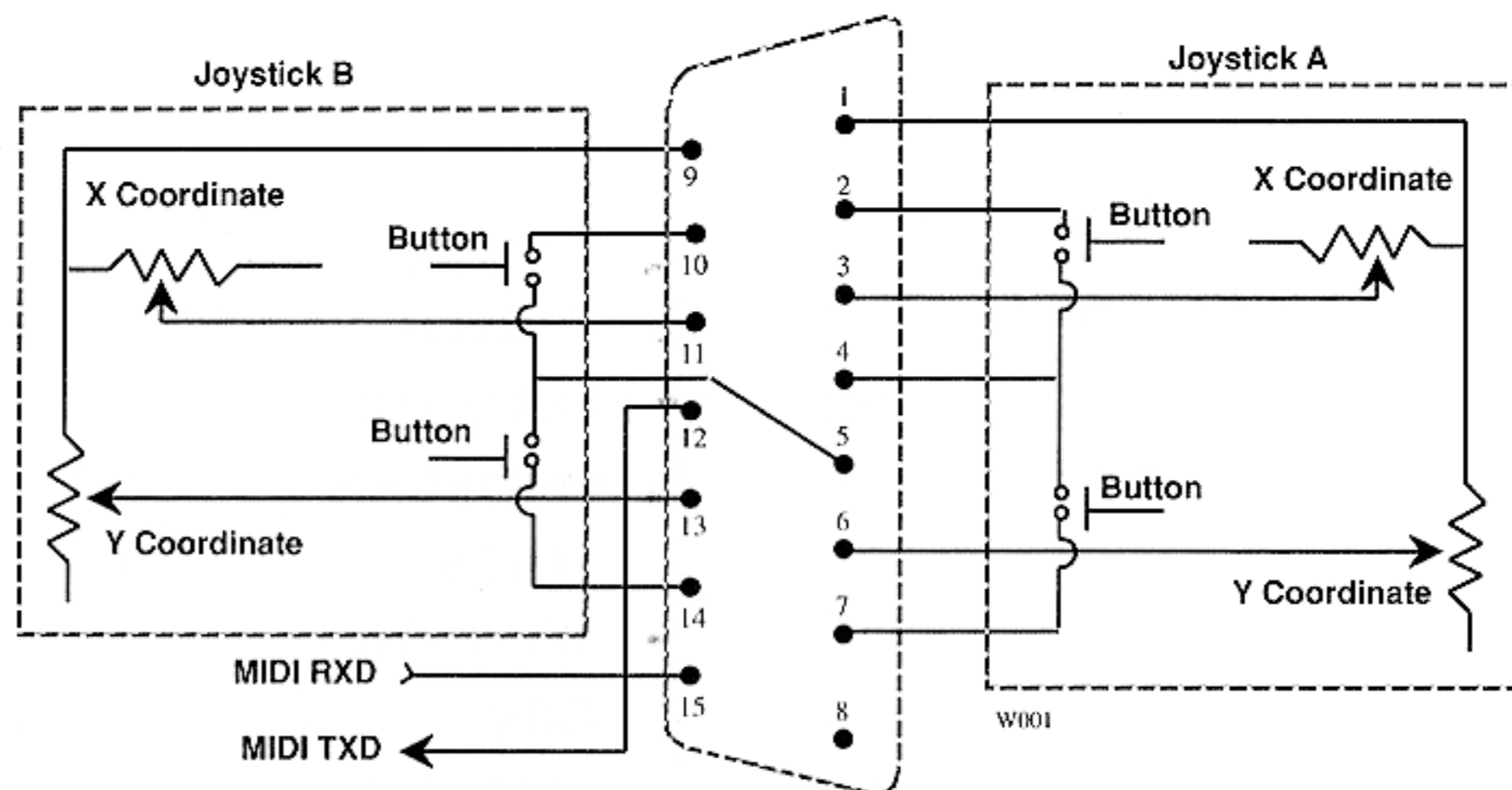

Software Installation

We have bundled several software packages with your Sound Blaster card to get you up and running as quickly and easily as possible. These include

- ▶ **Talking Parrot**
- ▶ **SB Talker**
- ▶ **Dr. Sbaitso**
- ▶ **FM Intelligent Organ**
- ▶ **VOX Kit**
- ▶ **Windows 3.0 DLL and Application**

Some of the data files bundled with the Sound Blaster card are compressed. You have to decompress these files before you can use them. The hard disk installation program, **INST-HD**, will decompress these files during the process of installation. Refer to Appendix D if you wish to decompress these files manually.

To install software:

1. Insert **Sound Blaster Disk #1** in your floppy drive.
2. Change to the floppy drive prompt (A: or B:) and type **INST-HD C:** and press **Enter**.

Note: This will install the software on your C: hard disk. If you wish to install it on another hard drive, D: for example, type **INST-HD D:** and press **Enter**.

The program installs Sound Blaster software under the directory **\SB** and creates several subdirectories automatically.

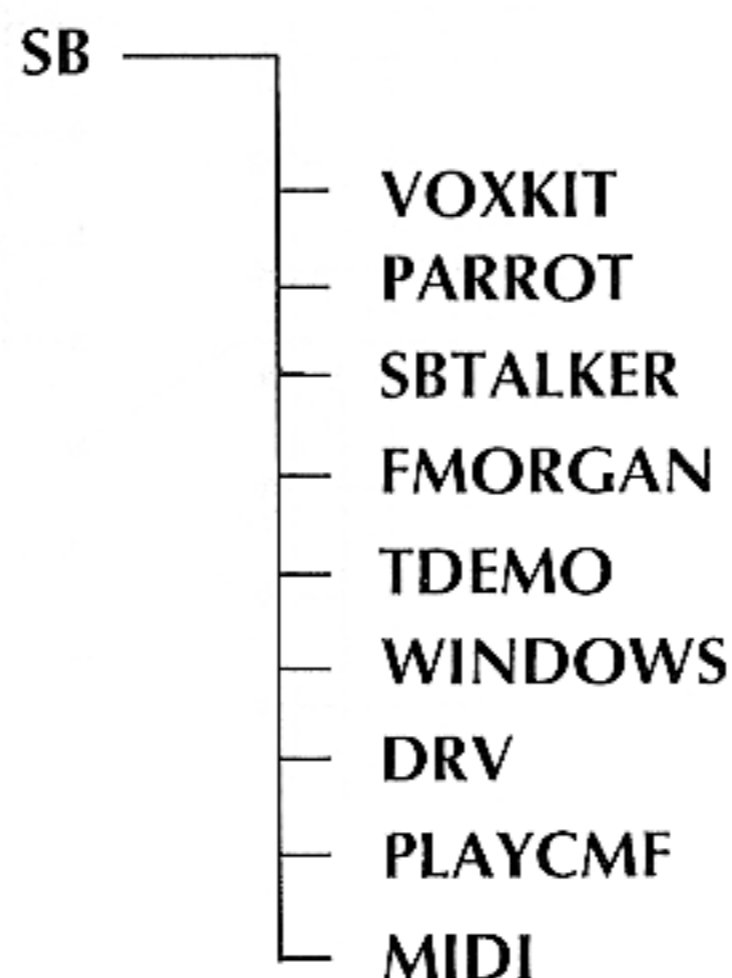

Setting the Sound Environment

Before you run any Sound Blaster software, two environment strings are required: **SOUND** and **BLASTER**. These are automatically added to your AUTOEXEC.BAT file when you install the software. However, you need to know how they are used if you decide to make any hardware or software changes. (For additional information on the Set command, please refer to your DOS manual.)

Set Sound

The install program modifies your AUTOEXEC.BAT file to include the command **SET SOUND=C:\SB** (assuming your Sound Blaster software is installed in C:). If you change the sound drivers to a different directory or drive, you will have to change the Set Sound command in your AUTOEXEC.BAT file to reflect this change.

The **SOUND** environment string specifies the directory location of Sound Blaster's sound drivers and other software. Many software packages rely on this environment setting to locate the sound drivers and other Sound Blaster files.

Note: There is no space before and after the = (equal) sign.

Set Blaster

The **BLASTER** environment string specifies base I/O address, interrupt and DMA channel hardware configuration of your Sound Blaster card. The command for setting the **BLASTER** environment string with factory default setting is **SET BLASTER=A220 I7 D1 T3** and it changes your AUTOEXEC.BAT file to reflect the factory default settings.

Where:

- A** specifies the base I/O port. It is either 220 or 240.
- I** specifies the interrupt line. It is 2, 3, 5 or 7.
- D** specifies the DMA channel one. (Can't be changed.)
- T** specifies Sound Blaster Card type. 1 is for earlier Sound Blaster cards, 2 is for the Sound Blaster Pro and 3 is your Sound Blaster Card.

Note: There is no space before and after the = (equal) sign. But, there must be at least one space between the two settings.

Installing Sound Drivers

This section is meant for those who have changed the default I/O port address and Interrupt. When hardware configurations are changed, the various drivers must be reinstalled to reflect these changes. This is necessary because applications developed for previous versions of the Sound Blaster cards do not support the **BLASTER** environment string. For these applications, you need to install the driver with your new hardware settings.

Changing Blaster Settings.

If you have changed the hardware configuration of the Sound Blaster card, use the **SET-ENV** program found in the **\SB** directory to identify the new hardware configuration on your card and modify the **BLASTER** string in your **AUTOEXEC.BAT** file.

Third Party Software

Sound Blaster is the sound card with the largest library of supporting software and we are constantly introducing new and innovative software.

Music and sound drivers are usually included in third-party software. Just pick the sound or music card from the install menu or from their instructions. The sound or music card is usually one of the following:

- ▶ **Sound Blaster Card**
- ▶ **Ad Lib Music Card**

SOUND BLASTER

VOICE UTILITIES

Voice Utilities	2-3
Sound Basics	2-3
Sampling Rate	2-4
Conventions Used	2-5
VOXKIT	2-5
Menu Description	2-6
Record Voice	2-6
Play Voice	2-7
Data Packing	2-7
Save File	2-8
Load File	2-8
VOC-HDR	2-8
JOINTVOC	2-8
VREC	2-10
VPLAY	2-11
VSR	2-12

SOUND BLASTER

VOICE UTILITIES

These voice utilities are helpful in creating and changing recorded sounds. They can be used in creating special batch files for multimedia applications. The following programs are found in the VOXKIT subdirectory:

- ▶ **VOXKIT** Main Program for recording, playing, packing and saving files.
- ▶ **VOC-HDR** Adds headers to raw voice files
- ▶ **JOINTVOC** Joins or combines voice files
- ▶ **VREC** Records voice to disk from the command line
- ▶ **VPLAY** Plays digitized voice from disk
- ▶ **VSR** Changes voice file's sampling rate

Sound Basics

However, before we get into using the voice utility programs, this short introduction to sound fundamentals might be helpful. Sound is nothing more than the movement or vibration of molecules in the air that cause other things to vibrate—like your auditory nerves that let you hear sound.

Sound, for our purpose, is represented by sine waves. Sine waves have two main characteristics—frequency and amplitude. Frequency is the number of cycles per second and has an effect on the pitch or timbre of a sound. Amplitude, represented by the height of a sine wave and also the loudness of a sound.

SOUND BLASTER

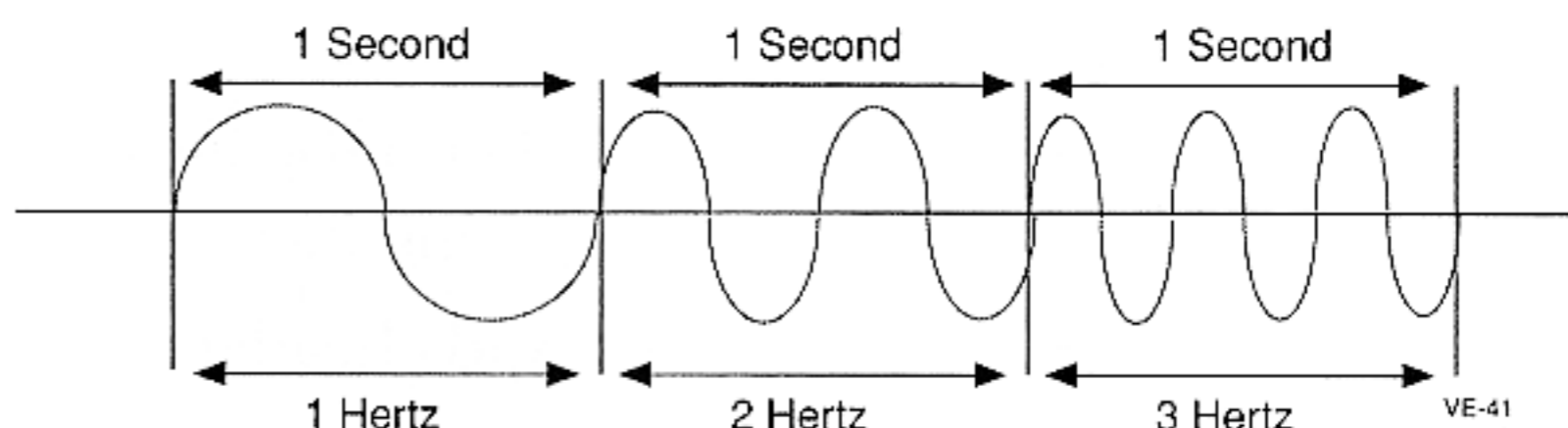
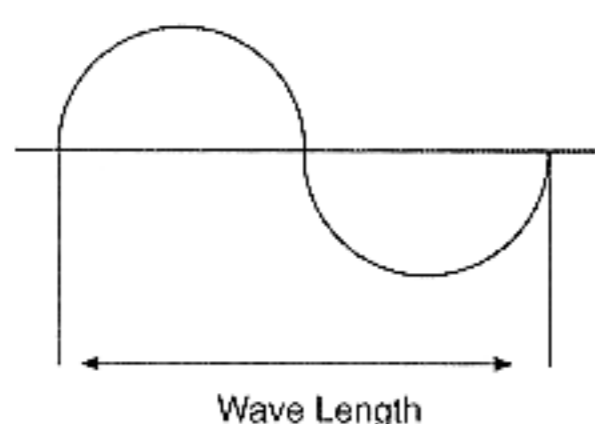
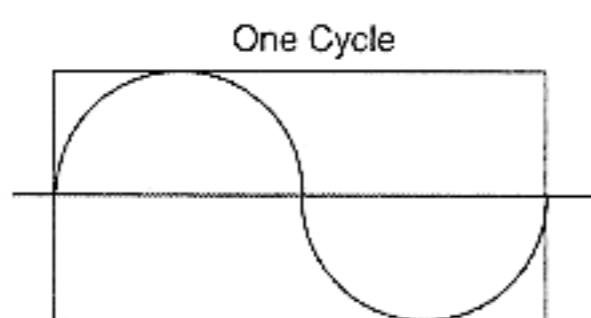
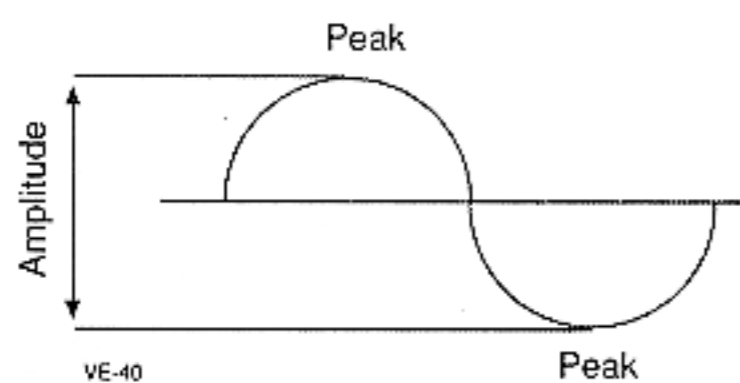

Frequency equals number of cycles per second



Original Sound Waveform

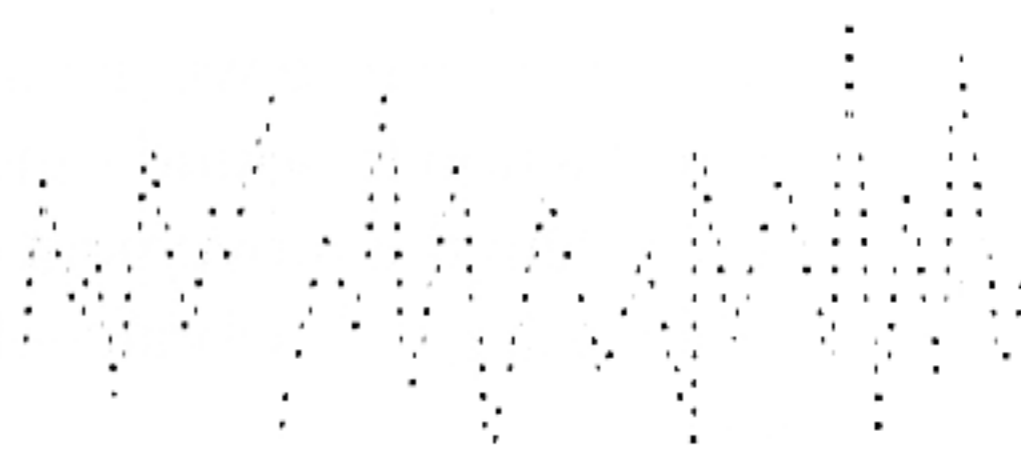

Digitized Waveform

Sampling Rate

Sound waves are not simple sine waves, but complex waves. When you record a sound with the Sound Blaster, it changes analog signals into digital signals.

Sampling is the number of times the Sound Blaster looks at a sound to create a digitized version or image of that sound. For example, recording sound at 4KHz, create 4,000 digitized images or samples in one second. When looking at a standard sound waveform, compared to a digitized image you can see bits of information make up the digitized image. In the case of VOXKIT, you can select between 4KHz (4,000 Hertz) and 15KHz when recording. This sampling rate affects the quality of sound—the higher the sampling rate, the better the sound. A CD player has a

sampling rate of 44KHz at 16 bits. With the Sound Blaster you can play sound at 44.1KHz

Since sampling rate is measured in frequency (Hertz), changing the sampling rate after recording changes the sound's pitch. If you decrease the sampling rate of a recorded voice file, you change the pitch to a lower tone.

Conventions Used

Most of the programs in this section have optional parameters that can be set. To eliminate some of the confusion, the following conventions and standards are used to describe files and parameters:

- ▶ **filename.voc**—Refers to a voice file. These can also be shown as **sourcefile.voc**, **targetfile.voc** and **file1.voc**. The **.VOC** extension refers to a Creative Voice File Format. All voice files are shown in bold.
- ▶ **Options**—Refers to optional settings for voice files. These options are usually listed inside brackets. You do not need to type the brackets when setting options. The lower case letters refer to variable settings for each option.

VOXKIT

This program let you record, play and compress digitized sound. It uses the CT-VOICE driver to perform all voice functions. You can also write programs that use the CT-VOICE driver as described in the optional *Software Developers Kit*. Voice files are saved in the Creative Voice File Format.

To start VOXKIT:

1. Change to the **SB\VOXKIT** directory.
2. Type **VOXKIT** and press **Enter**.

Note: You can add the option **/Bkk** to the VOXKIT to specify the buffer size for disk recording and playback. **kk** is the size of the buffer in 2K units. The input value range is 1 to 32. Entering 16 will give you a 32K buffer.

3. When the menu screen displays, use the **Arrow** keys or the **Alt** key plus the **highlighted** character to select the desired option and press **Enter**.

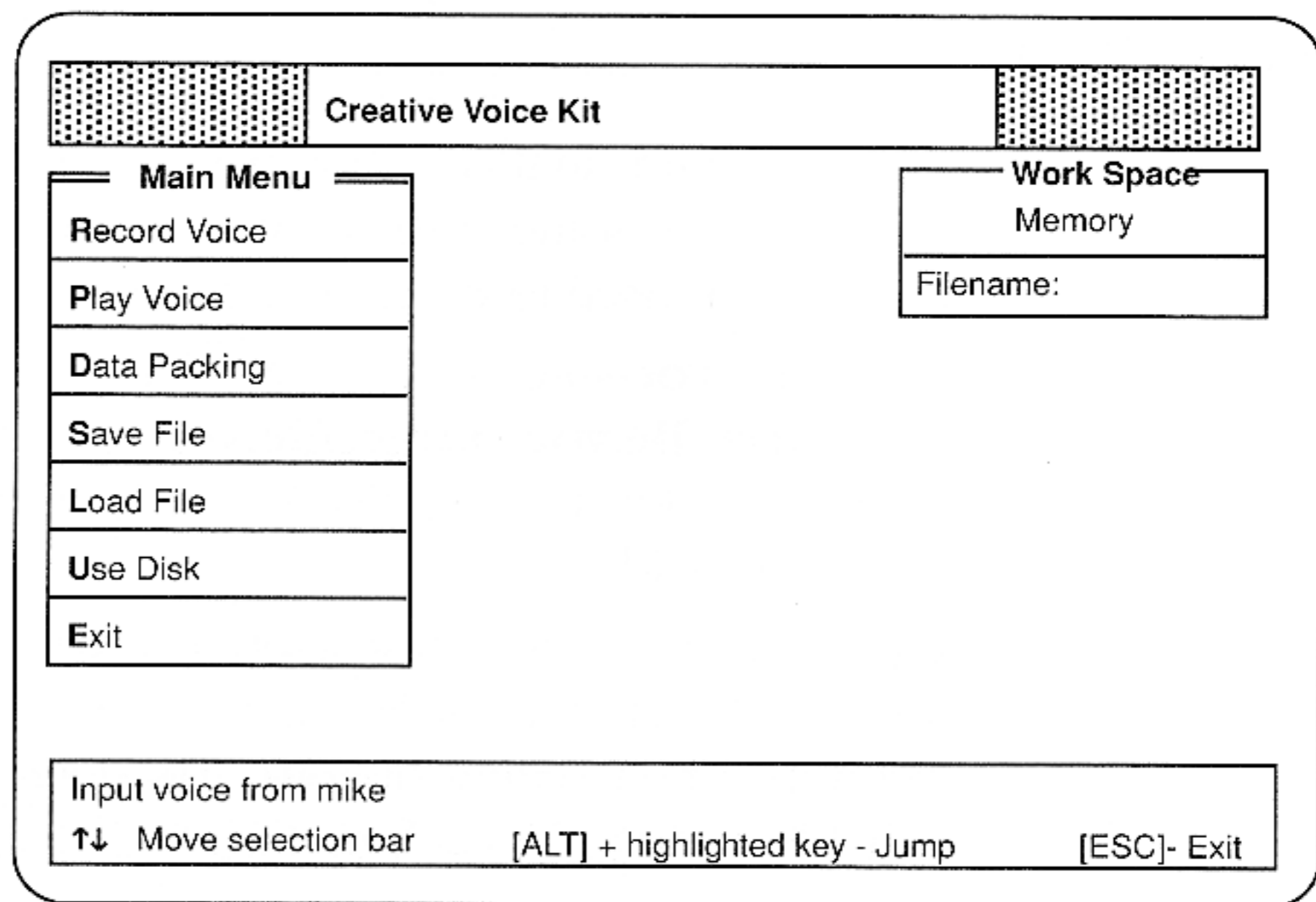

Menu Description

Record Voice

This lets you record a voice from microphone or line-in. You must first plug in a microphone to the microphone jack or other sound device source to the Line-in jack.

Important: Microphone and Line-in jack cannot be connected at the same time.

The default sampling rate is 8,000Hz (Hertz). You may change this sampling rate from 4,000 to 15,000Hz. Hertz is the number of samples recorded per second. At 8,000Hz, you are taking 8,000 one-byte samples. The data rate is 8,000 bytes of memory consumed for one second of recorded sound. This sampling rate is good for a female voice.

For a male voice, use a lower sampling rate of 6,000Hz to conserve memory. When you record to memory, if you want to keep the file, it is necessary to save it. If you are recording to disk, you will need to supply a file name before recording.

Play Voice

This option lets you play the voice files you have recorded from memory or from disk files. The program selects the correct sampling rate, compression format, etc. from the information provided in the file header.

Data Packing

This provides a method of compressing files to conserve hard disk space. There are four packing methods available:

- ▶ **4 bit ADPCM**—This gives you a 2:1 compression ratio. It is nearly impossible to hear any voice quality degradation using this compression ratio.
- ▶ **2.6 bit ADPCM**—This is a 3:1 compression ratio. Quality is only slightly affected.
- ▶ **2 bit ADPCM**—This 4:1 compression ratio has a significant effect on sound quality. It is recommended for use in situations where conserving memory is important, or where noise is part of the sampled sound, such as an explosion, thunder, gun shots, etc.
- ▶ **Silence Packing**—This does not compress a file, but replaces long duration of silence with a few bytes, thereby saving memory with no loss of quality.

Important: You must perform Silence Packing before any ADPCM compression is done. Once you compress a file, you cannot remove the silence or pack it further.

If you have recorded good data and want to try different packing methods, it is recommended that you save the original data before packing it. You can load the original data again to try other packing methods.

Save File

This option lets you save your recorded or packed file in memory to disk. You must provide a file name without an extension. The default extension for all voice files is **.VOC**.

Load File

This function loads a voice file from the current directory. A window shows all **.VOC** files in the current directory. Use the **Arrow** keys to move to a file and then press **Enter**.

Selecting a subdirectory is done by moving the cursor to the subdirectory filename and pressing **Enter**. You can also move to a higher directory by moving to the two dots (**..**) and pressing **Enter**.

All **.VOC** files must be saved in the CreativeVoice File Format before they can be loaded. If you want to compress a raw voice file, you will have to first use the **VOC-HDR** program to add a header before VOXKIT can load the file. Once a file is loaded, you can then play or pack the file.

VOC-HDR

This program adds the Creative Voice File header to a raw sound file recorded from other sources. With the header added, Voice Editor and other programs using the CT-VOICE driver can then play the sound file.

Entry format:

VOC-HDR sourcefile targetfile.voc

Important: It is necessary to put the **.VOC** extension on the target file.

JOINTVOC

With this utility you can combine two or more voice files into a new file.

Entry format:

SOUND BLASTER

JOINTVOC / Ttargetfile.voc file1.voc file2.voc [/Saa /Mbb /Rcc /RE]

Note: The parameters [/Saa/Mbb/Rcc/RE] can be added to each voice file to be combined. Decimal values for *aa*, *bb* and *cc* cannot be greater than 32767.

Example: If you want to join three files, where **file2.voc** repeats five times and then pauses for two seconds after playing **file2.voc**, this is entered as:

JOINTVOC / Ttargetfile.voc file1.voc /R5 file2.voc /RE /S20 file3.voc

Option	Description/Specifications
Saa	Adds a silence period to a voice file in units of 0.1 seconds.
Mbb	Adds a marker to the file. During playback of the voice, if the marker is encountered, it sends a 2-byte flag. An application program can then decide how to act when encountering these flags.
Rcc	Requests a block to be repeated. If cc equals -1 requests non-stop repeating.
RE	Ends the repeat command.

VREC

With this utility you can record a voice from the DOS command line. The voice is recorded directly to the diskette or hard disk using a double-buffering technique. The length of the recorded voice file is limited only by the disk capacity.

Entry format:

VREC filename [/B:kk] [/S:hh] [/T:ss] [/Q] [/X="command line"]

Option	Description/Specifications
<i>filename</i>	Is the filename to store the recorded voice. The default extension is .VOC. The voice is stored in the Creative Voice File format.
<i>/B:kk</i>	Sets the buffer size used for recording. The program uses two buffers during the recording process. kk is the size of the buffer in 2K units. If the buffer is not specified, a default value of 16 is assumed for kk (32K bytes per buffer). You can enter a range from 1 to 32 for kk.
<i>/S:hh</i>	Sets the recording sampling rate (frequency). The range for hh is from 4000 Hz to 15000 Hz.
<i>/T:ss</i>	Sets the recording time in one second units. The range for ss is from 1 to 65535, giving a maximum recording time of about 18.20 hours. (Note: This function will not work when /X switch is specified.)
<i>/Q</i>	Specifies Quiet screen mode operation. When specified, except for error messages, all other messages are suppressed.
<i>/X="command line"</i>	Go to DOS to execute a DOS command or another program after the voice process is activated. command line specifies the DOS command or a program to be executed containing up to 16 parameters.

VPLAY

You use this program to play a voice file from the DOS command line. The voice file can be any size and must be in Creative Voice File Format.

Entry format:

VPLAY filename [/B:kk] [/T:ss] [/Q] [/X="command line"]

Option	Description/Specifications
<i>filename</i>	This is the voice file to play. The default extension is .VOC. The voice file must be in the Creative Voice File format.
<i>/B:kk</i>	Sets the buffer size for playback. The program uses two buffers during the playback process. kk is the size of the buffer in 2K units. If the buffer is not specified, a default value of 16 is assumed for kk (32K bytes per buffer). You can enter a range from 1 to 32 for kk.
<i>/T:ss</i>	Sets the playback time in one second units. The range for ss is from 1 to 65535. (Note: This function will not work when /X switch is specified.)
<i>/Q</i>	Specifies Quiet screen mode operation. When specified, except for error messages, all other messages are suppressed.
<i>/X="command line"</i>	Go to DOS to execute a DOS command or another program after the voice process is activated. command line specifies the DOS command or a program to be executed containing up to 16 parameters.

VSR

This program lets you change or edit the sampling rate of your voice file. You can also play the voice file from this program once you have changed it.

Entry Format

VSR sourcefile targetfile.voc /Rnn [/O]

Option	Description/Specifications
<i>sourcefile</i>	The Creative Voice File to process.
<i>targetfile.voc</i>	The file that will hold the changed file.
<i>/Rnn</i>	This sets the new sampling rate as a percentage of the current sampling rate. For example, if the current sampling rate is 10,000 and you want to change it to 8,000, enter the value 80. Or, if the current sampling rate is 8,000 and you want to change it to 10,000, you would enter 125 for nn.
<i>/O</i>	Using this option lets you play the voice file after changing. This option specifies the value to use to determine the silence to be removed. The default value for nn is 2. The smaller the value, the tighter the silence will be.

SOUND BLASTER

SBTALKER

TEXT-TO-SPEECH SYNTHESIZER

SBTALKER - Text-to-Speech Synthesizer	3-3
Removing SBTALKER	3-4
EMS Memory	3-4
Using the Read Program	3-4

DR. SBAITSO

YOUR PERSONAL CONSULTANT

Dr. Sbaitso - Your Personal Consultant	3-6
Getting Started	3-6
Exploring Dr. Sbaitso	3-6
Dot Commands	3-7

SOUND BLASTER

SBTALKER

TEXT-TO-SPEECH SYNTHESIZER

This text-to-speech synthesizer program is a memory-resident module that reads ASCII text and has an unlimited vocabulary. There are two application programs included with SBTALKER:

- ▶ **Read**—this program reads ASCII text files, text entered from the DOS command line, and text sent through communications ports.
- ▶ **Dr. Sbaitso**—a fun program that attempts to converse with you in English.

Important: You must load SBTALKER in memory before Read and Dr. Sbaitso can run. Remember, if you have not put the Set Sound command in your AUTOEXEC.BAT file, you need to enter the command, **Set Sound=C:\SB** before you can play Sound Blaster software.

To load SBTALKER:

- ▶ Change to the **SB\SBTALKER** directory.
- ▶ Type **SBTALK** and press **Enter**.

Note: SBTALK is a batch file (SBTALK.BAT) located in the SB directory. You can run the program by entering **SBTALKER /DBLASTER** to specify the speech driver, BLASTER.DRV.

To set echo effect:

- ▶ After installing **SBTALKER**, type **SET-ECHO [dddd]** and press **Enter**.

Note: *dddd* sets the delay time for the echo effect. The range is from 0 to 4,000. Entering 1,000 provides a good echo effect with about a 0.1 second delay. A delay setting of 500 produces a reverb effect.

Example: **SET-ECHO 500**

Removing SBTALKER

SBTALKER will stay in memory until you remove it or reboot. You may not be able to run other applications with SBTALKER in memory.

To remove SBTALKER from memory:

- ▶ Change to the **\SB\SBTALKER** directory.
- ▶ Type **Remove** and press **Enter**.

Important: To effectively remove SBTALKER, it must be the last program loaded in memory.

EMS Memory

SBTALKER automatically loads itself into Expanded Memory (EMS) memory, if the proper EMS driver is installed in the system. SBTALKER is compatible with most EMS drivers in the market. However, if you have one that doesn't work properly with SBTALKER, it may be necessary to remove this EMS driver to run SBTALKER.

Using the Read Program

READ can read text typed at the DOS prompt and ASCII text files. There are three entry formats:

- ▶ **Read "any text"**
- ▶ **Read**
- ▶ **Read <standard-input [/W]**

Note: The **/W** option display the text while reading.

Example: Read <sbtest.txt/W

SOUND BLASTER

To have this program say "Hello, how are you?" :

1. At the DOS prompt type **Read "Hello, how are you?"** and press **Enter**. (or type: **Read hello, how are you?** and press **Enter**.)

To read an ASCII file:

1. Type **Read <sbtest.txt** and press **Enter**.
2. Press the **ESC** key to quit the program.

To read ASCII from the communications port, COM1:

1. Type **Read <com1** and press **Enter**.

To read text entered from the keyboard:

1. Type **Read** and press **Enter**.

The program will read entered text line by line until you press **CTRL-C** to quit.

Note: SBTEST.TXT is an ASCII file supplied with the software. However you can ask **READ** to read any ASCII text and you can type in a path to where the file is located.

Example: Read < C:\SB\Readme.txt.

Dr. SBAITSO

YOUR PERSONAL CONSULTANT

The program Dr. Sbeitso seems to act intelligently by responding to your queries. You can ask Dr. Sbeitso any type of question or tell him your problems. Dr. Sbeitso uses a synthesized voice to reply as he tries to solve your problems.

Getting Started

To load Dr. Sbeitso:

- ▶ Change to the **SB** directory.
- ▶ Enter **SBAITSO2 [/40]** and press **Enter**.

Note: The **/40** is an optional parameter. **/40** set the screen to 40 column mode, for example: **SBAITSO2 /40**.

Important: Remember, before you can run Dr. Sbeitso, you need to have SBTALKER loaded in memory.

Exploring Dr. Sbeitso

When the screen displays, just follow the instructions. Dr. Sbeitso is more enjoyable if you try to find ways to make the Doctor understand you by using key phrases. Dr. Sbeitso will try to satisfy your questions. However, he performs best when you talk about your problems and use complete sentences.

We don't want to spoil your fun by telling you too much about Dr. Sbeitso. You can have more fun exploring Dr. Sbeitso yourself. If you want Dr. Sbeitso to repeat a response, press the **R** key.

To make the conversation more interesting, use the **.ECHO ON** command (See Dot Commands). This will cause the SBTALKER to say what you type using a different voice. Dr. Sbeitso can also perform some simple mathematics. If you feel that you are not getting much help from Dr. Sbeitso, type in the word **HELP**.

Dot Commands

Enter these commands in Dr. Sbeitso preceded by a period.

Dot Command	Description/Specifications
.QUIT	This lets you quit the program. (You can also quit by typing BYE or GOODBYE .)
.READ	With this command, Dr. Sbeitso can read an ASCII text file. Format: .READ filename .
.TONE t	This command sets the tone— t is either 0 (Bass) or 1 (Treble).
.VOLUME v	Sets the volume. — v ranges from 0 (Lowest) to 9 (Loudest)
.PITCH p	Sets pitch. — p ranges from 0 (High) to 9 (Low).
.SPEED s	Sets the speaking speed. — s ranges from 0 (Slowest) to 9 (Fastest)
.PARAM tvps	Sets tone (0 or 1), volume (0 to 9), pitch (0 to 9) and speed (0 to 9).
.ECHO ON	This lets the program read what you type. .ECHO OFF will turn it off.
.COLOR x	Sets the background screen color. x ranges from 0 to 7.
.WIDTH 80 or 40	Sets screen width to 80 or 40 columns.
.HELP	Enters the help mode.

SOUND BLASTER

THE TALKING PARROT

The Talking Parrot	4-3
Getting Started	4-3
Video Display Selection	4-4
Customizing Your Parrot	4-4
Making Parrot Voices	4-5
Talking Parrot Voice Files	4-5

SOUND BLASTER

THE TALKING PARROT

Getting Started

This mischievous parrot likes to mimic speech. It talks back, sometimes with outrageous remarks and it even giggles when tickled. The purpose of this software is to provide you with a demonstration of the power of your Sound Blaster card and to give you some hands-on experience in using its voice capabilities combined with graphics.

You can say anything you want, in any language. You can press any key or simply leave it alone and see what happens.

Important: This program requires an AT (286) computer to run properly. A microphone plugged into the Sound Blaster card is also required. If the microphone has a switch, make sure it is turned **ON**.

To start the program:

1. Change to the **\SB** directory.
2. Type **PARROT** and press **Enter**.
3. When the screen displays a graph indicating noise level, press **Enter** and type a number that is ten counts above the noise level displayed (140 to 230) and press **Enter** again.

Example: If the graph displays 130, type **140** and press **Enter**.

4. When the parrot finishes its opening remarks, speak into the microphone.

Important: Speak directly into the microphone with sufficient volume so that the parrot can hear you.

5. Press the **Escape** key to leave the program.

Video Display Selection

Normally, the TALKING PARROT software automatically detects which type of video display you have and selects the correct mode. On the CGA screen, you will notice that parrot is enlarged. This is because TEXT mode is used here to draw the parrot.

If you would like to have this big "text" parrot on you EGA or VGA display, you may use a parameter to force the TALKING PARROT to use this TEXT mode. **Example:** > **PARROT /T**

Customizing Your Parrot

For those who want more fun out of the Talking Parrot, you can customize it by creating your own pictures and voices. There are four PCX format pictures used to make up the parrot. You can use any paint or draw program that saves in the .PCX format to create your own version of the Talking Parrot.

Give your drawings the same file names as those listed in the table and copy them to the **\SB\PARROT** directory.

Parrot .PCX Picture Files		
EGA/VGA	CGA	Description
PARROT.E0	PARROT.CO	Parrot with mouth closed
PARROT.E1	PARROT.C1	Parrot with mouth open
PARROT.E2	PARROT.C2	Parrot with mouth wide open
PARROT.E3	PARROT.C3	Parrot with eyes and mouth closed

The 4 CGA pictures are created using text characters.

Making Parrot Voices

The pre-recorded voices for the Talking Parrot are stored in the PARROTV.VCB file. This file contains all 21 voices. To create your own voices, use VOXKIT to record the 21 voice and give them the same names shown in the Talking Parrot Voice Files table. Stores these files in the SB\PARROT directory.

To create the .VCB file:

- ▶ From the \SB\PARROT directory type **MAKEPV** and press **Enter**.

Important: Make sure that:

- ▶ All files are recorded at 10,000Hz sampling rate
- ▶ The voice data is **NOT** packed
- ▶ Each voice data in each file does not exceed 64K
- ▶ The sum of the size of the 21 voices must **NOT** exceed the free memory after the Talking Parrot is loaded. To be on the safe side, keep the file size less than 250K.

Note: The program MAKEPV used to create the PARROTV.VCB file checks for the existence of the original PARROTV.VCB file and ask for your permission to overwrite it.

Talking Parrot Voice Files

The following tables contain the 21 voice files that make up the PARROTV.VCB.

SOUND BLASTER

Random Greeting Message Files	
File Name	Description
PVOC-A.VOC	Hello there
PVOC-B.VOC	Hi ! how are you ?
PVOC-C.VOC	Good day
PVOC-D.VOC	Welcome to the show.
PVOC-E.VOC	I'm a talking parrot.
PVOC-F.VOC	Please talk to me.
PVOC-G.VOC	Nice to see you.
PVOC-H.VOC	Please say something.
PVOC-I.VOC	Have a nice day.
PVOC-J.VOC	Goodbye.

The Parrot will say files PVOC-A, PVOC-E and PVOC-D at start up. When you quit the parrot says PVOC-J and PVOC-I.

Random Reply Message Files	
File Name	Description
PVOC-K.VOC	Oh ! You sound terrible
PVOC-L.VOC	Yak ! You have bad breath
PVOC-M.VOC	What are you saying?
PVOC-N.VOC	What are you saying? (angrily)
PVOC-O.VOC	Don't talk nonsense

The Parrot will randomly refuse to play back the recorded voice and will send out one of these messages instead.

Reaction Message to Keyboard Files	
File Name	Description
PVOC-P.VOC	Ouch
PVOC-Q.VOC	Ooo..h
PVOC-R.VOC	Don't touch me
PVOC-S.VOC	Go away
PVOC-T.VOC	Hee..hee..hee
PVOC-U.VOC	Herr..herr..herr

When the keyboard is pressed, the Parrot will randomly send out one of these messages

FM INTELLIGENT ORGAN

FM Intelligent Organ	5-3
Getting Started	5-3
Play Mode	5-4
Keyboard Terminology	5-4
Getting To Know Your Keyboard	5-6
Save, Load & Replay	5-7
Save	5-10
Load	5-10
Non-Stop Replay	5-10
Instruments and Accompaniments	5-11
Instruments	5-12
Auto-Bass Chord	5-12
Auto Arpeggio	5-13
Artificial Melody	5-14
Tempo Control	5-14
Volume Control	5-15
Time Signatures	5-16
Major/Minor Scale Solution	5-16
Transposing	5-17
Changing Octaves	5-17

Contents Continued

Black Keys and the Small Keyboard	5-17
Buffer Status	5-18
Default Settings & Other Functions	5-18
More Functions-F8	5-20
Learn Mode	5-20
MIDI Mode	5-21

FM INTELLIGENT ORGAN

The FM Intelligent Organ transforms your computer into an organ of incredible power and you into an instant musician. With one finger—or all ten, if you can manage—you can learn to play complex musical pieces on your computer keyboard—the software adds the accompaniment (bass, chord and rhythm) in real-time.

We have included a Learn Mode to help you master the keyboard—without stopping to learn music theory. And, if you have a MIDI-compatible keyboard, using our MIDI interface, increases your music-making capabilities tenfold.

Getting Started

To load:

1. Go to the `\SB\FMORGAN` directory.
2. Type **FMORGAN** and press **Enter**.

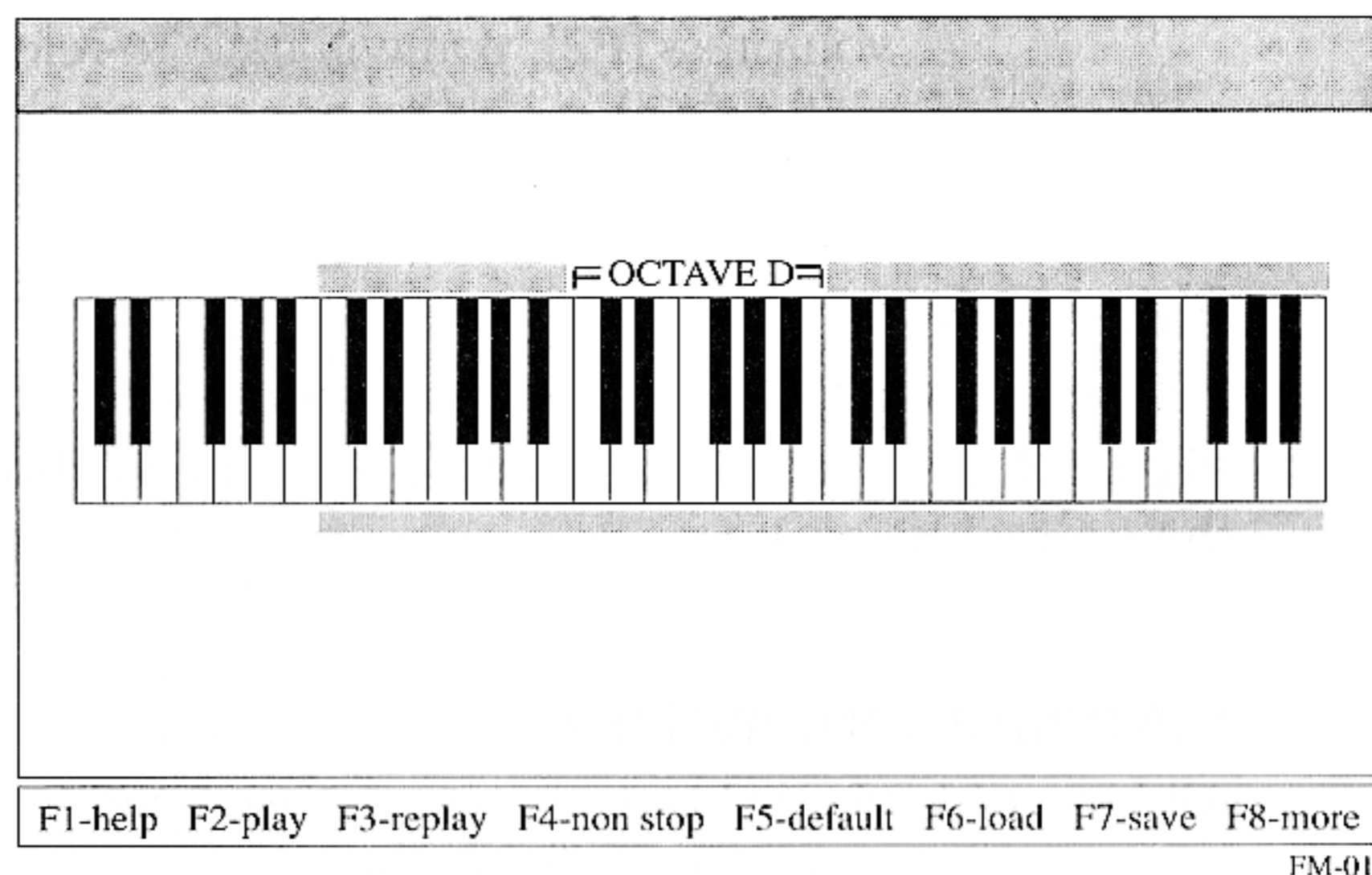

Figure 1 — Main Menu

If you have no fear of computers or keyboards, set this manual aside, press **[F2]** and begin playing with the keyboard. You can press the **[F1]**

and the **Page Up/Down** keys to display a brief help summary of key definitions.

After playing around for a while, you will have a feel for the keys and how they are used. Then, when you need additional information, come back to the manual.

There is a song provided in your **\SB\FMORGAN** directory called **DEMO**. Feel free to load it in for replay, non-stop replay with all kinds of effects; changing instruments, accompaniments, tempo, etc. Go on and have a good time — you can't damage anything by playing the organ, and the **HELP** menu is always there to guide you.

To load a song:

1. Press **[F6]**.
2. Use the **Arrow** keys, **Page Up** and **Down** keys to highlight and select a song from the list of songs displayed.
3. Press **[F4]** to play the song.

Important: After loading, if you press **[F2]** to play the song, you will hear only the rhythm and arpeggio—**NOT** the melody. If you press **[F2]**, you will have to reload the song to play it with melody.

Play Mode

Before you start to key in anything, you need to know which keys to play. **Figure 2** gives you a good picture of the PC keyboard representation of the normal piano keys.

Keyboard Terminology

All keys of keyboard instruments are arranged in groups of 12 keys (5 black & 7 white keys). Each of this group is called an Octave and the first white key of each Octave is a "DO", the second white key "RE", the third "MI" followed by "FA", "SO", "LA", "TI".

SOUND BLASTER

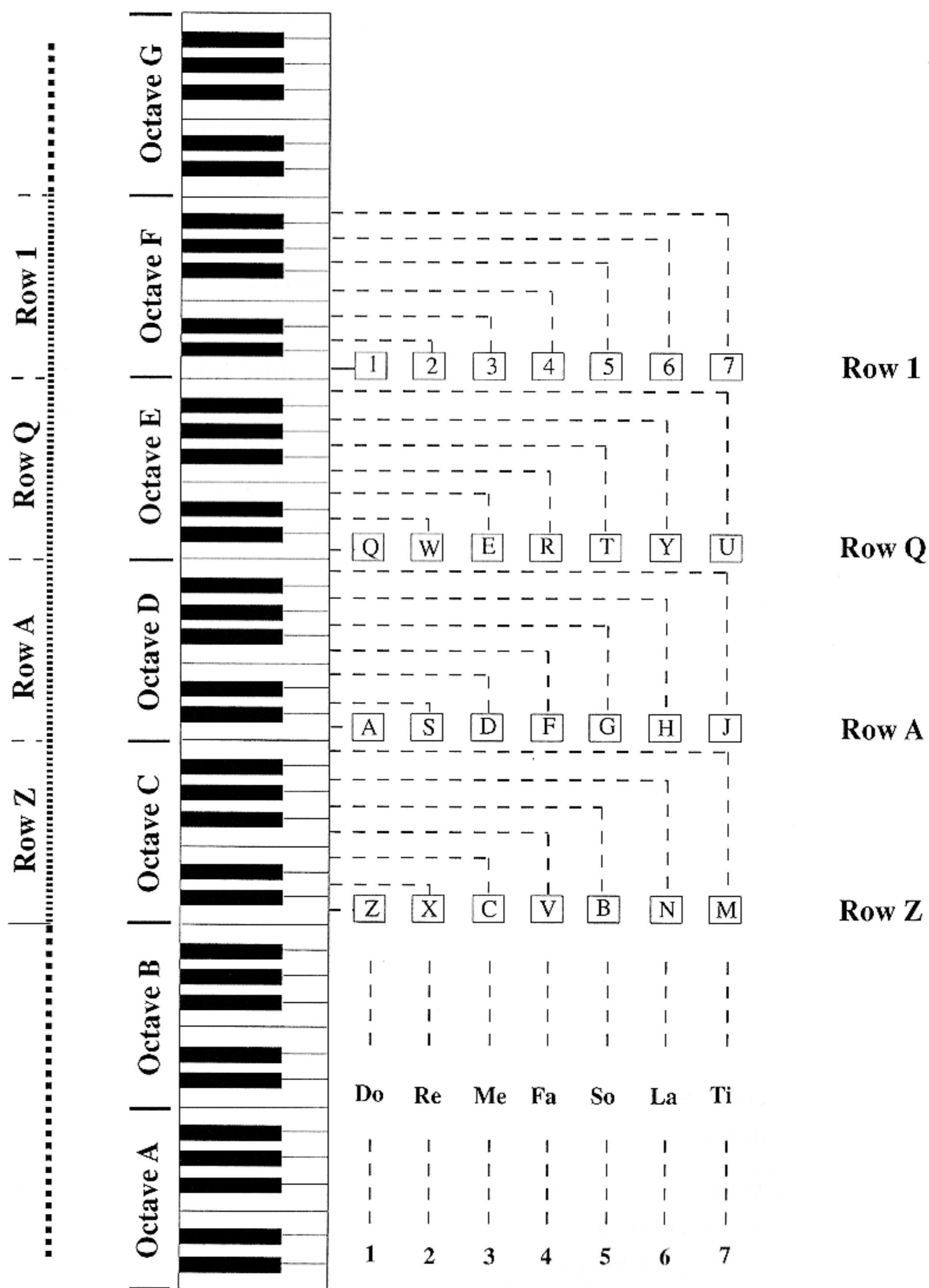

Figure 2 — Seven Octave Piano Keyboard on Your PC

The Middle C is the “DO” note located at the middle of a piano keyboard and in the case of the Intelligent Organ, it is the “DO” note of the D Octave. This Organ program has a very large keyboard; the equivalent of a large organ keyboard. There are 7 Octaves available and for convenience, we named them as Octave A, B, C, D, E, F and G.

Getting to Know Your Keyboard

At the main menu, hit the **[F2]** function key to enter play mode.

Press the ← or → keys on the numeric keypad to shift the green color bar above the organ keyboard. Notice that the position of the D-Octave is always indicated. If you observe carefully, you will also notice that the length of the moving green bar always covers 4 octaves. These four octaves represent the four rows of keys on you PC keyboard, namely row **1**, row **Q**, row **A**, row **Z**, used for playing the organ.

For example, if the D-Octave is at the left hand side of the green bar, it means that the row **Z** represents the D-Octave. On the other hand, if the D-Octave is shifted to the right hand side of the green bar, then row **1** represents the D-Octave.

Have you pressed **[F2]** yet? Go ahead, press **[F2]** and start messing around with those “piano keys”.

Try playing any of these keys on you PC and you should hear the corresponding notes. If you cannot hear any sound, please check the volume control on your sound card and refer to Appendix C: Quick Reference for Problems Solving.

You can actually go on playing (or messing around) for hours, but let us stop for a while so that you can “show off” your musical talent by getting a bit more sophisticated (and I’ll “show off” what this organ can do for you).

For those of you who don’t seem to be able to find something to play, you can try one of my favourite tunes on page 5-8 and 5-9.

Play by pressing the keys corresponding to the number on the notes.

SOUND BLASTER

E.g. The first 7 notes are (① ① ⑤ ⑤ ⑥ ⑥ ⑤)

You can use any of the 4 octaves, that is, any of the 4 rows to play.

If you chose row "1", type: (1 1 5 5 6 6 5)

If you chose row "Q", type: Q Q T T Y Y T

After you have played the whole song, let's try playing it differently one more time. This time hit the space-bar first and start playing when the number counting on the top-left corner is **1**. You will hear beautiful background music being added to what you are playing. Press **[ESC]** to quit PLAY mode after playing the song.

Save, Load & Replay

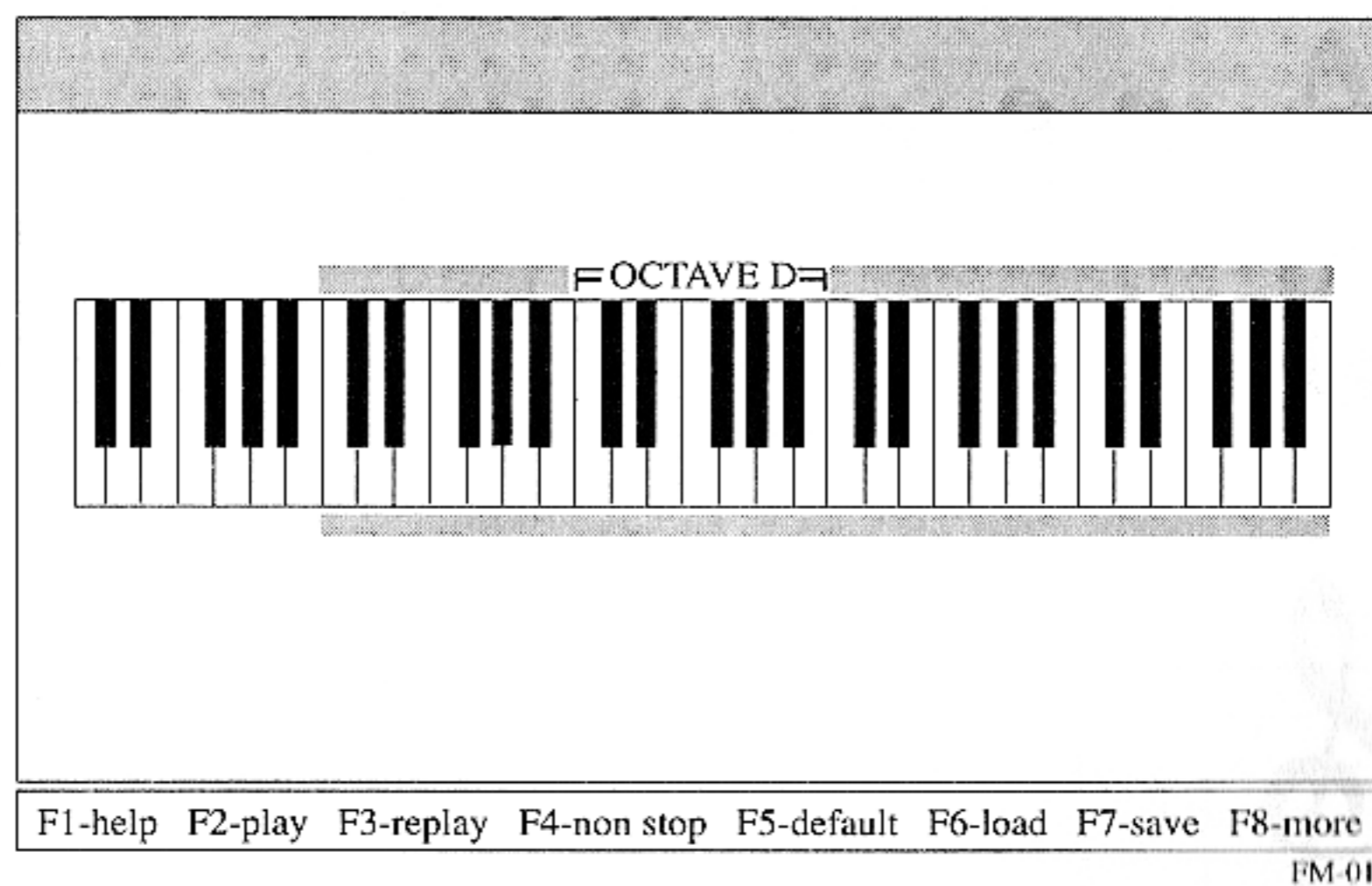

Figure 4 — Main Menu

TWINKLE, TWINKLE, LITTLE STAR

(filename : TWINKLE)

KEY 1=C

Rhythm = March

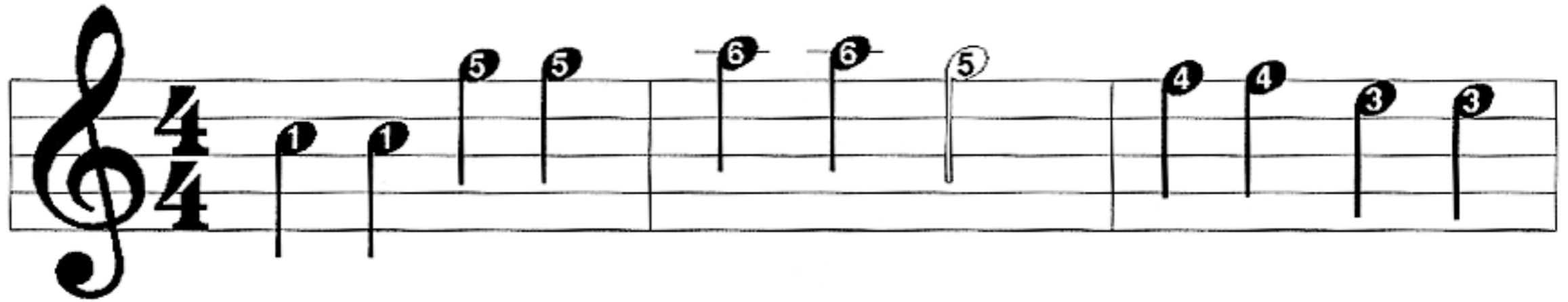

Twin - kle, twin - kle lit - tle star, how I won - der

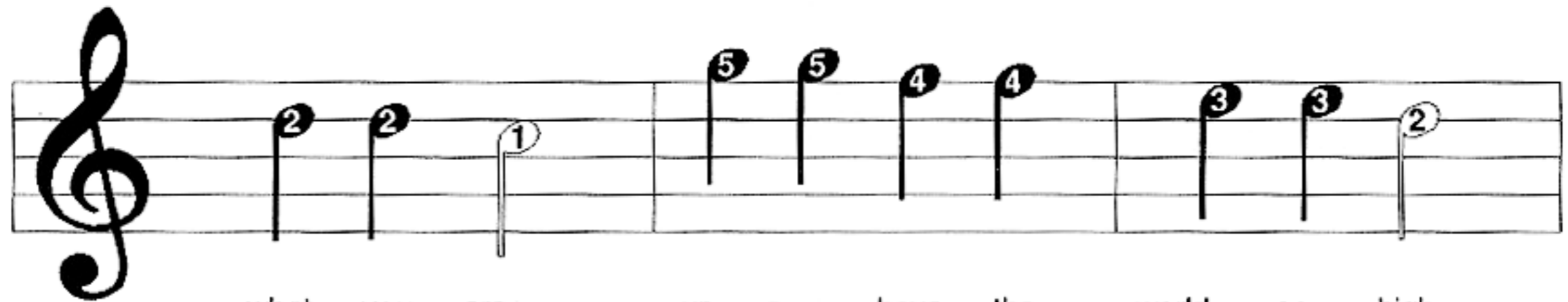

what you are, up a - bove the world so high.



like a dia - mond In the sky, twin - kle, twin - kle

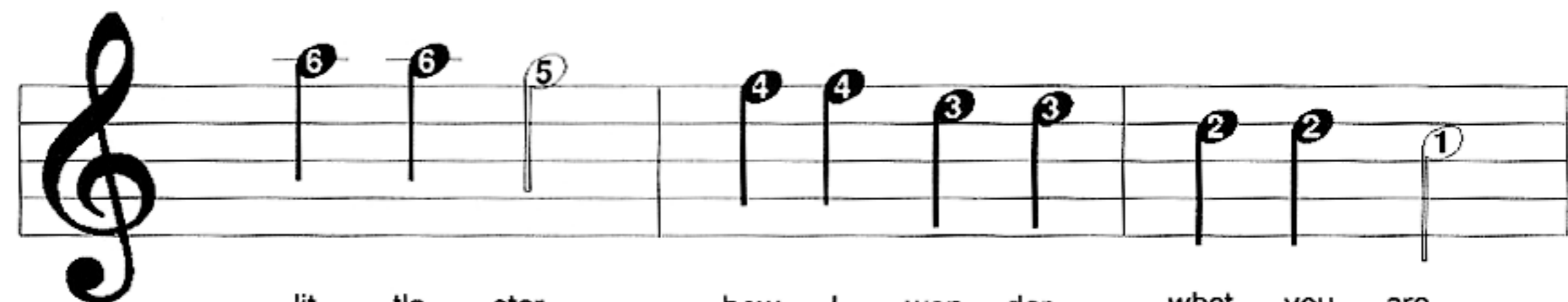

lit - tle star, how I won - der what you are.

WHEN THE SAINTS GO MARCHING IN

(filename : SAINTS)

KEY 1=C

Rhythm = March

Oh, when the saints go marching in,

Oh, when the saints go march - ing in,

I want to be In that num - ber

when the saints go march - ing in,

Save

Wonderful, isn't it?! Since this is your first song on the Organ, I am sure you would like to save it to show your friends. Press function key **[F7]** and you will be prompted to key in the name of the song.

Type "MYSONG1" and press **[Enter]** and the song that you've just played will be saved onto the disk. The Intelligent Organ actually "remembers" the song you are playing by storing it temporarily in a reserved memory area in your computer. We call this area the "BUFFER" and during a 'SAVE' operation, the contents in the buffer is transferred onto the disk.

Perhaps you would like to play the song again before you save. Hit **[F2]** to play again. Then press **[Esc]** to quit; and use **[F7]** to save the song.

Load

Just to make sure that you have saved your song correctly, press **[F2]** to go to the PLAY mode and then press the **[Esc]** key to return to the main menu; going to the PLAY mode will wipe out the song that is stored in the buffer. Now press **[F6]** to load back the song that you have just saved.

A pop up menu containing all the song titles on your disk will be displayed. Simply move the cursor to the song you want and hit **[Enter]**. That song will be loaded into memory.

Non-Stop Replay

To hear the song that you have loaded, press **[F4]**. The song will be played back repeatedly until you press the **[Esc]** key. You may make changes to your song while in this "non-stop" mode but the changes made are temporary and will not be saved in the buffer.

Have you tried loading the "DEMO" song on the Intelligent Organ disk yet? If not, let's do it now! At the main menu hit **[F6]** and select DEMO. The song DEMO will be loaded from the disk. Next, hit **[F4]** for non-stop replay. You are now invited to modify the song by changing the instrument, rhythm etc. Isn't it fun? Go on, the power is with you, turn

the song upside down.

Try loading other songs for a non-stop replay. Have fun with them.

To make “permanent” changes you will have to press **[F3]** to replay. In this mode, the song will only be replayed once and to hear the song again, you will have to press **[F3]** once more. Changes made in this ‘replay’ mode are stored in the buffer and are therefore permanent. To avoid changing the DEMO song permanently, enter a different song title such as “DEMO2” when a filename is asked for during saving.

Instruments and Accompaniments

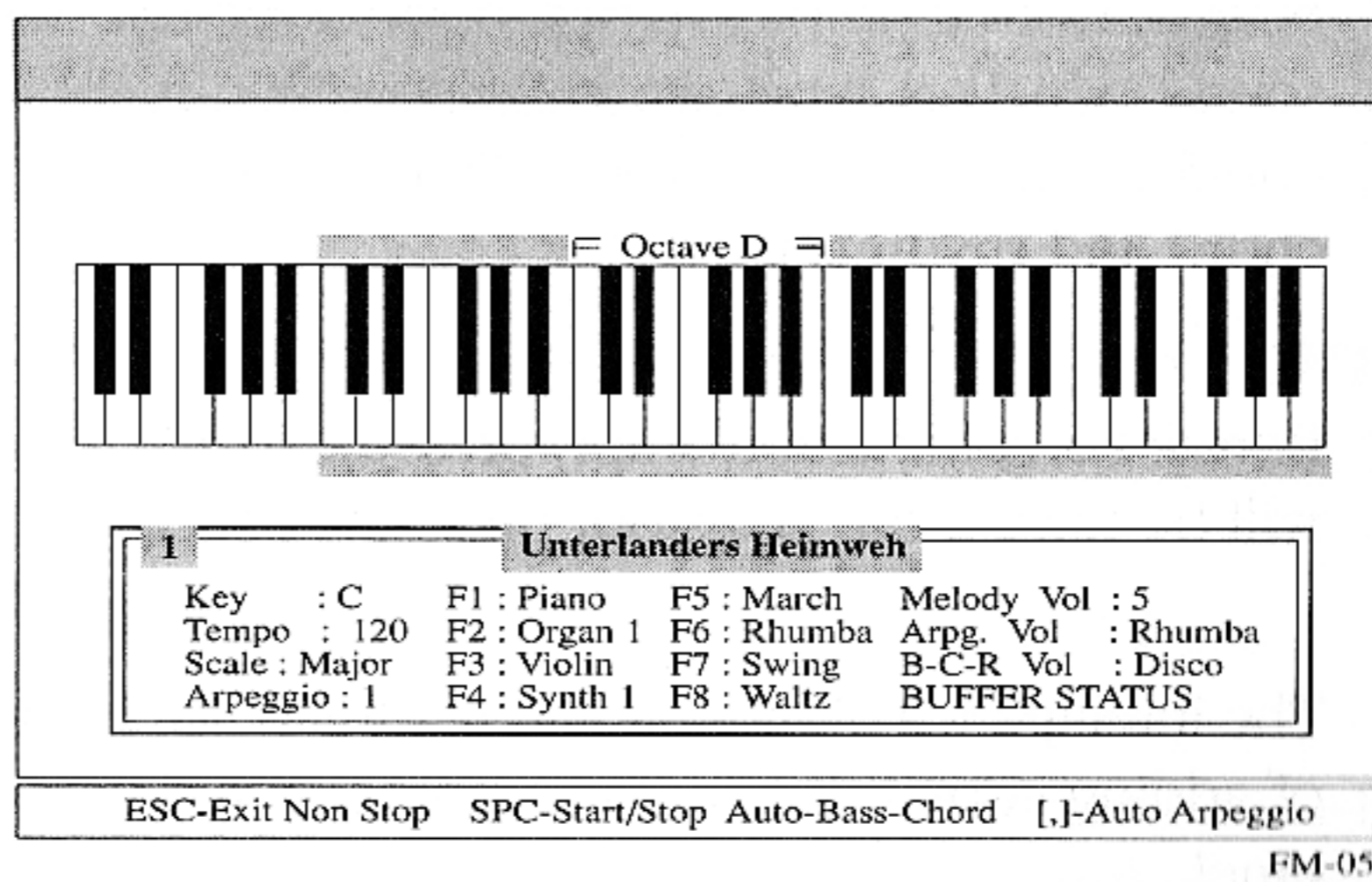

Figure 4 — Play Menu

Instruments

Press **[F2]** to get to PLAY mode. Notice the menu in the PLAY mode? Try pressing function keys **[F1]** to **[F4]** and what do you notice? Some words in the main menu begin to change color.

Go on, choose something and start to play your tune. You can change instruments any time you fancy — simply press any of the keys **[F1]** to **[F4]**.

Each function key actually supports 5 instruments giving a total of 20 instruments. Pressing a function key continuously allows you to switch among the five instruments.

Auto-Bass-Chord

Playing a simple tune is not so difficult after all, but most tunes you've heard are not simple. They normally come with some background sound which is what we call accompaniment. The accompaniment enriches the quality (in most cases) of the main melody by adding bass, chord and rhythms to it.

Bored? For some action simply press the space bar and the accompaniment will be turned on. To stop, press the space bar once more.

The intelligence of the Intelligent Organ lies in the fact that it is capable of adding correct accompaniments to what you are playing — in real-time!

Certain accompaniment will suit some songs better than others and the Intelligent Organ gives you a choice of 16 different accompaniments to choose from. Try changing the accompaniment by pressing any of the function keys **[F5]** to **[F8]**.

Notice that most songs have a proper ending so that they sound right when ended and not abruptly interrupted. Try ending the auto accompaniment for various types of Auto-Bass-Chord accompaniment by hitting **[Enter]** key.

SOUND BLASTER

Now, with more power at your finger tips, you are ready to take on the "Twinkle, Twinkle, Little Star" again and mesmerize your audience with a vastly sophisticated version. Choose an instrument you like and select "March" for your Auto-Bass-Chord accompaniment. Don't forget to give your song a proper ending before saving it. Name it MYSO2.

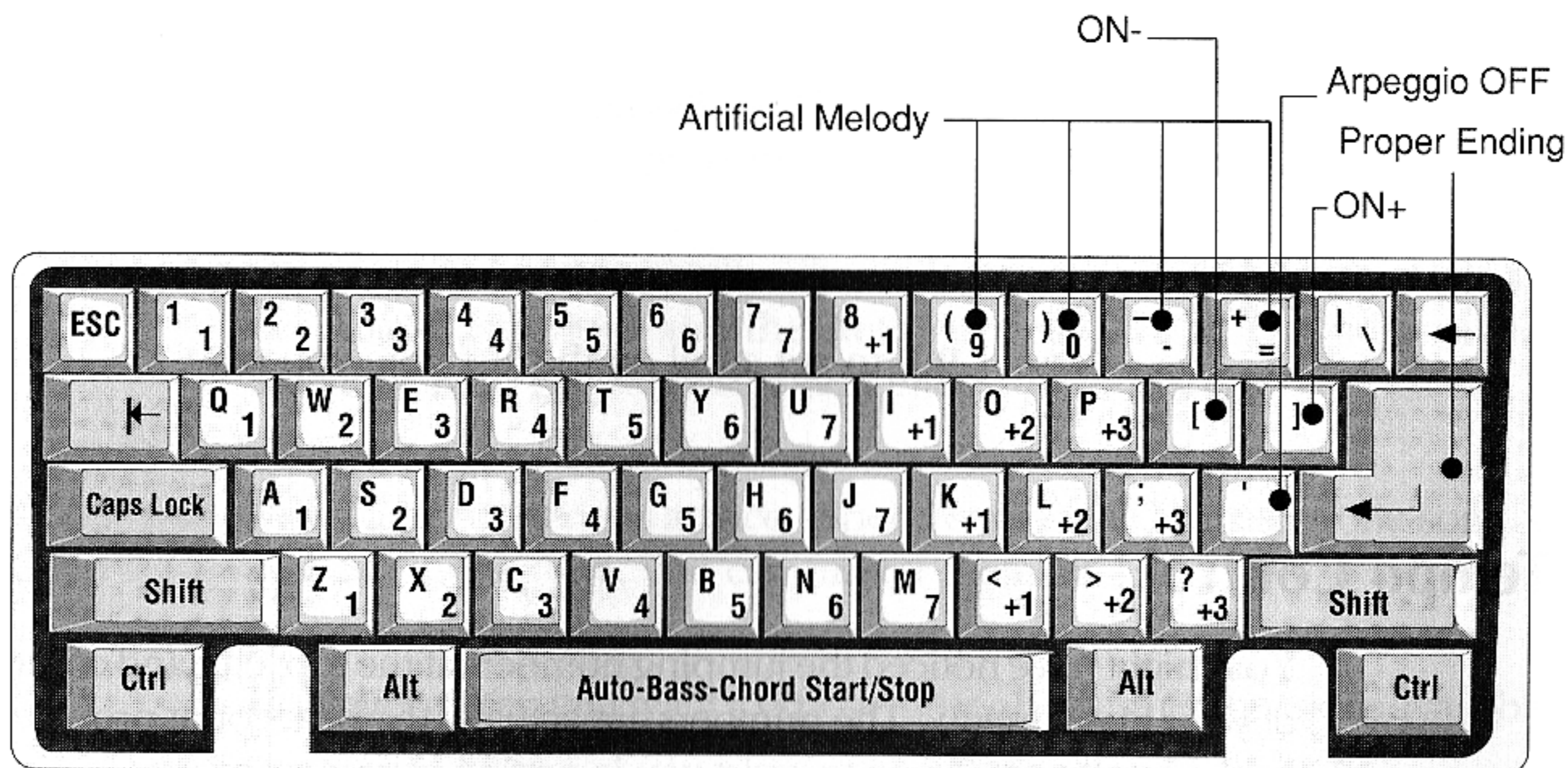

Figure 5 — "Piano Keys" equivalent and Auto-Bass-Chord, Auto-Arpeggio and Artificial Melody control keys.

Auto Arpeggio

Ready for more fun now? In addition to the Auto-Bass-Chord accompaniment, the Intelligent Organ gives a further enhancement to your songs by providing an Auto Arpeggio — automatically adding a built-in harmonious melody to accompany your main melody. You can select any one of the six arpeggios using the [or] keys. How about adding more spice to MYSO2 using Auto Arpeggio. That's a good way to get to know them better.

Use the ["] key to stop the Auto-Arpeggio

Artificial Melody

Instead of the Auto-Arpeggio, you can also add a string of melodies to what you are playing. This artificial melody is provided by the following four keys:

[9], [0], [-] and [=]

The best effect is achieved by pressing one of the artificial melody keys during the long notes of your song.

E.g.

Press [9] to get a trill on the last note you play.

Tempo Control

You might have noticed the jumping numbers at the top left hand corner of your PLAY menu. The numbers are actually the beat count provided by the Intelligent Organ to assist you in getting your tempo correct. You can vary the tempo by pressing:

[**Ins**] — Increase Speed

[**Del**] — Decrease Speed

If you are still struggling to get your song right, because you cannot keep

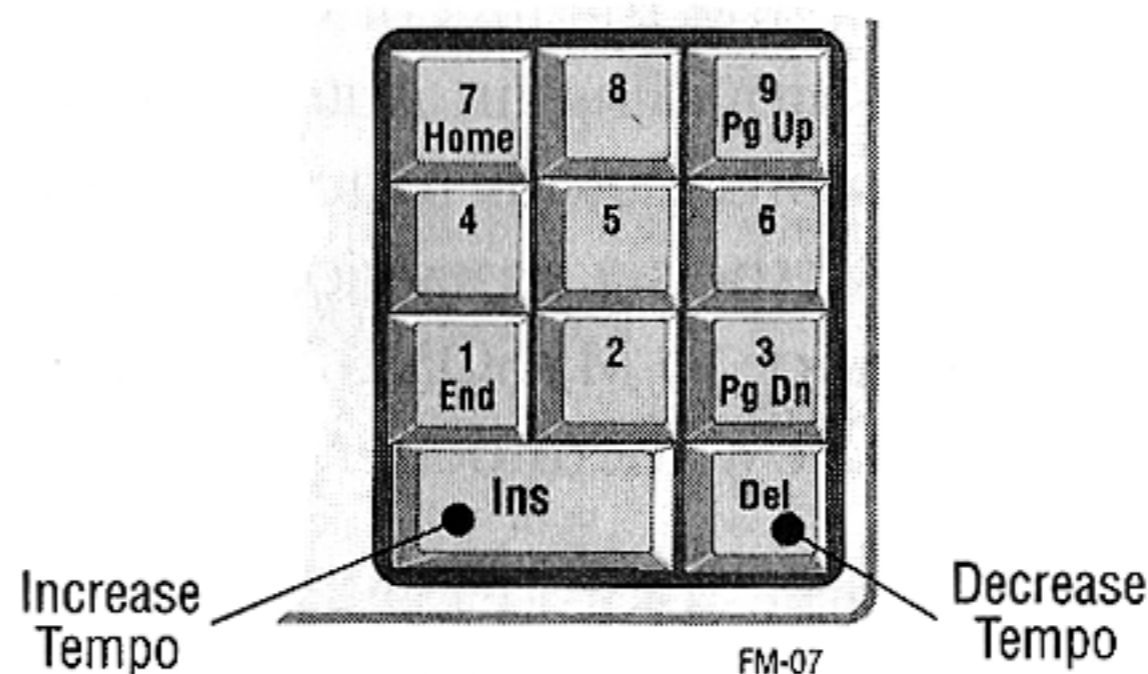

Figure 6 — Tempo Increase/Decrease Keys

up with the pace of the song, don't despair. Simply decrease the tempo until you can key in your song comfortably. Add Auto-Bass-Chord and Arpeggio and you will still get to your sophisticated piece somehow. You can then increase your tempo gradually as your skill gets better. (Let me show you a "crooked way" — play your song in a slow tempo and replay it in a regular tempo).

Volume Control

Besides the master volume control on the Music Card itself, the Intelligent Organ has three individually adjustable volume controls for the Melody, the Auto-Bass-Chord and the Auto Arpeggio. You can adjust them individually to get the best sound effect for your songs.

Now for some serious advice: Spend some time to master one song. If you can master one, you can master them all.

However, when you want to know more about other functions available

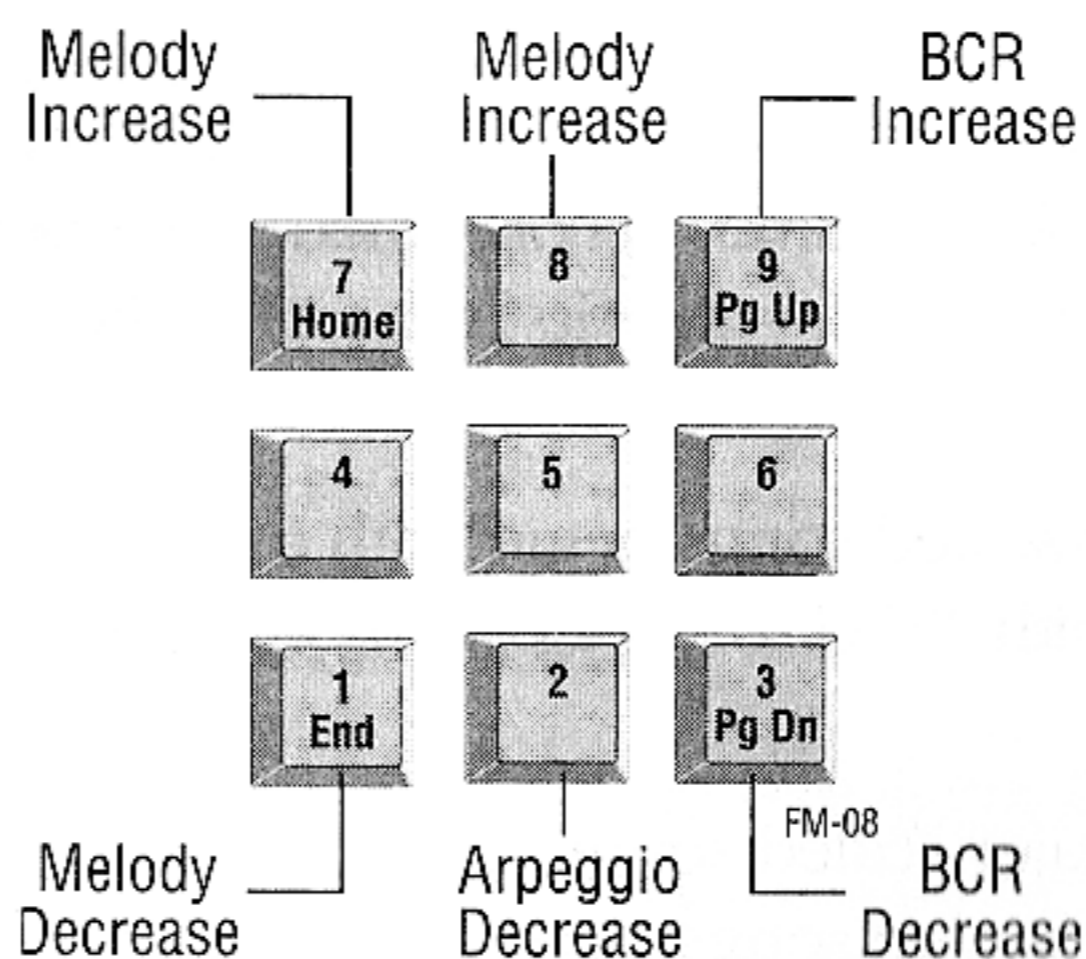

Figure 7 — Volume Control

on your organ, you can refer to the next two chapters.

Time Signatures

At the beginning of a musical score, there is always a Time Signature. The most common are:

$\frac{3}{4}$ and $\frac{4}{4}$ which denote 3 beats and 4 beats respectively.

For songs with $\frac{3}{4}$ time signature, you should use only the waltz-type rhythms found on **[F8]**.

Major/ Minor Scale Selection

[F9] — Major Scale Accompaniments

[F10] — Minor Scale Accompaniments

Most songs can be categorized as a major-scaled song or a minor-scaled song.

As a rule of thumb, major-scaled songs begin with a major chord or end with “1” (DO) — the first note of its key.

Minor-scaled songs begin with a minor chord (Eg. Am, Em, Dm,...) or end with “6” (LA) — the sixth note of its key.

For major-scaled songs, use Major Scale Accompaniment **[F9]**, and for minor-scaled songs, use Minor Scale Accompaniment **[F10]**, so that the accompaniments sound proper.

Generally speaking, we use **[F9]** major accompaniment unless the songs ends with “6” (LA) or begins with a minor chord. Only then we choose **[F10]** minor accompaniment.

Transposing

Not every song is written in C key (1=C) — i.e. C is the “DO” note. Some tunes sound better if they are played in a higher key while others sound better in a lower key. Moving your “DO”, “RE”, “MI”, etc to a higher or lower tone is called TRANSPOSING. The Intelligent Organ gives you a very convenient one-touch way of transposing:

On the numeric key-pad, press

[+]	Transpose music one-semitone up
[-]	Transpose music one-semitone down
[shift] [+]	Transpose a perfect fourth
[shift] [-]	Transpose a perfect fifth

To hear the effect of transposing go to the main menu and press **[F6]** to load in a song. Next press **[F4]** for a non-stop replay and, while the song is being played, press the [+], [-], **[Shift]** [+] and **[Shift]** [-].

Changing Octaves

There are 7 Octaves playable from the Music Card and 4 Octaves are directly accessible at any time from your PC keyboard. You can gain access to all seven by using the [←] and [→] keys on the numeric key pad to shift to the rest of the octaves.

Black Keys and the Small Keyboard

Besides the four octave keyboard, the Intelligent Organ also provides users with a small keyboard with directly accessible “Black Keys”. Those who would like to play the “Black” Keys directly can hit the **[Tab]** key to toggle to a small keyboard (see fig. 9) with only 2 octaves.

The 4 rows hence becomes:

Row 1	-	Black keys	(Octave E)
Row Q	-	White keys	(Octave E)

SOUND BLASTER

- Row A - Black keys (Octave D)
- Row Z - White keys (Octave D)

If the black keys are accidentals, which occur rarely in your songs, you can play the black keys on the big keyboard by holding **[Shift]** down while playing.

Buffer Status

The song you played is stored automatically in a memory buffer. The size of this buffer is 64 K bytes.

Under normal conditions, the word "Buffer Status" appearing on the bottom right corner is blue in color. When the buffer is almost full, it will flash in red color. When the buffer is full, it will appear as red.

When the buffer is full, you can carry on playing, except that what you play subsequently will not be stored in the buffer.

When you activate **[F7]** - SAVE, the contents of the buffer are saved on the disk. When you load a song from the disk, the song is loaded into the buffer.

Default Settings & Other Functions

The defaults for functions like instruments, rhythm styles, speed, title of songs, etc. can be set by pressing **[F5]** from the main menu. When in the Default Setting mode, you can use the \uparrow & \downarrow to select the function. Alternatively you can jump to that function by pressing the highlighted character. Next use the \leftarrow or \rightarrow to rotate the various options available in that function. Stop at the option you want.

To enter the title of the song you must hit **[T]** and then type not more than 24 characters. After having set all the default settings you desire, hit

SOUND BLASTER

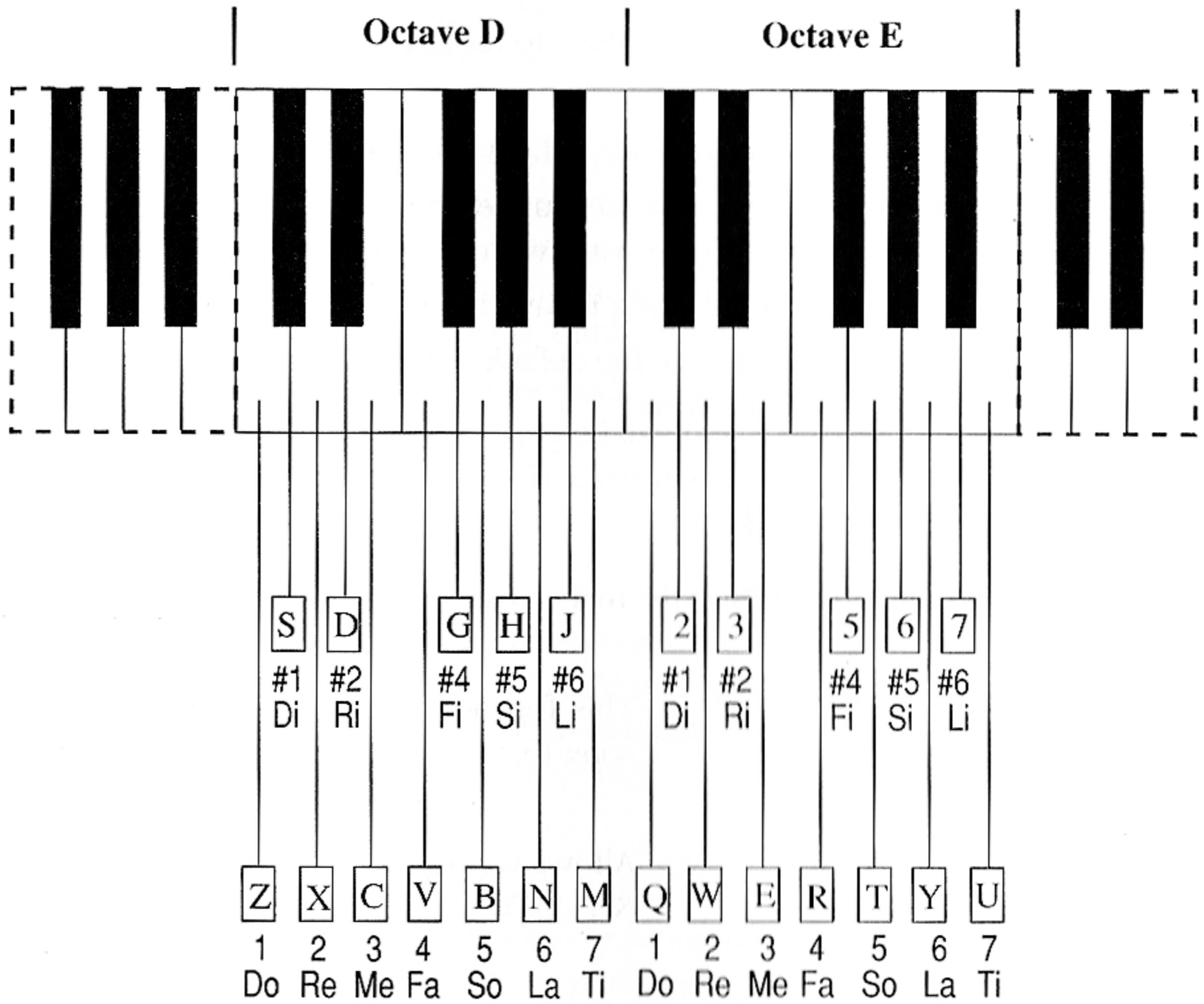

Figure 8 — Small Keyboard Layout

[Enter] to end.

Hit [Esc] if you wish to abort all changes to the setting and quit.

Hit [O] to restore all values to factory settings.

It is important to set your default settings because:

- ▶ You will be able to change your instruments, accompaniments, etc. to what you want with one touch of a button.
- ▶ The default setting is saved together with the songs.
- ▶ You can change the default settings after you have played a song or loaded a song.

More Functions—F8

When you hit [F8] in the main menu, you will be offered more functions:

F1 - LEARN	This function allows you to learn an organ song that is loaded in the memory buffer.
F2 - PATH	Allows you to set the directory path for SAVE & LOAD.
F3 - SHELL	Allows you to SHELL to DOS temporarily; for example, to perform a DIR command: Type EXIT to return to ORGAN
F4 - QUIT	Quit the Organ and return to DOS
F5 - MIDI TOGGLE	Enter or exit MIDI mode

Learn Mode

The learn mode [F8] + [F1] is a very easy way to learn to play any organ song without having to know any music theory. It shows you how the

notes of the song are to be “typed” on the actual PC keyboard.

First load a song that you like to learn using the **[F6]** (load) Function.

Then hit **[F8]** and **[F1]** to enter the Learn mode.

Hit **[F1]** (demo) again to see a demonstration of how the keys should be “typed”.

Then hit **[F2]** (learn). You will first see a brown bar on the upper half of a key. This is the warning signal for you to get ready to hit this key. When the bar turns into purple and drops to the bottom half of the key, this is the exact time that you must hit the key. If you do not hit the key in time, the song will wait, until you hit the correct key.

By practising on a song repeatedly, you should be able to play it without assistance after a while. If you have never played a musical instrument before, try it now, this will be really exciting.

MIDI Mode

The FM Intelligent Organ supports the MIDI interface of the Sound Blaster card. You can play the FM Intelligent Organ using a normal organ keyboard. You can play with one hand and have the Intelligent Organ add the accompaniments for you.

This is what you need to do :

1. You need to get an electronic organ keyboard (or synthesizer) that has a MIDI interface plus the optional MIDI Kit for SOUND BLASTER (cables are supplied with the MIDI Kit).
2. Connect the MIDI Kit to the Joystick Connector on the SOUND BLASTER.
3. Plug the MIDI cable from the MIDI-IN on the MIDI Kit to the MIDI-OUT on the MIDI keyboard.
4. Switch on the MIDI keyboard and set it to MIDI mode. (Refer to the keyboard manual if you don't know how to do it.)

5. Next, run the INTELLIGENT ORGAN software.
6. Hit Function Key **[F8]**-more then **[F5]**-midi-toggle.

This will activate the MIDI mode of the FM Intelligent Organ and enable it to receive MIDI codes from MIDI keyboards. You can still use the PC keyboard to play notes and change the ORGAN functions.

7. Next, you will see a "MIDI MODE" window on the screen. You are supposed to select the key signature that you are going to play. This is necessary so that the ORGAN can add the correct accompaniments to your song.

Use the four arrow keys to change to the desired key signature. If you are not sure, count the number of sharps or flats in the key signature of your music score. Match the number of sharps or flats with those on the windows.

- ▶ **up arrow**—incr no. of sharps or decr no. of flats
- ▶ **down arrow**—decr no. of sharps or incr no. of flats
- ▶ **left arrow**—lower a semitone
- ▶ **right arrow**—raise a semitone

When you've selected the desired key signature, hit [Enter] and you will return to the main menu. The MIDI mode is now turned ON.

8. Hit **[F2]** to play. You can now play on the MIDI keyboard as well. The use of the MIDI keyboard will not hamper the functions of the FM Intelligent Organ. Change of instruments, rhythms, tempo, keys, etc. can still be executed using the PC's keyboard.
9. If your song changes key signature midway through the song, you

must also let ORGAN know. Use the transpose functions;- **Shift** **[+]** or **Shift** **[-]** on the numeric keypad to match the key signature on the screen with that you are playing.

10. When you save a song after you have played on the MIDI keyboard, you may play back the song like any other ORGAN song played on the PC's keyboard. You will not hear the tunes from the MIDI keyboard. MIDI-OUT to the MIDI keyboard is not implemented.
11. The song that you have saved has been transposed to its "natural key signature":- the key signature whereby the song may be played without any black keys. During playback, ORGAN transposes it back to the original key signature. This has the advantage, that your song could be easily "LEARN"ed by others.
12. To end the MIDI-MODE, hit **[F8]** and **[F5]** one more time.

SOUND BLASTER

WINDOWS 3.0 APPLICATIONS

Windows 3.0 Applications	6-3
Installation	6-3
Setting the Windows Environment	6-4
Setting the WIN.INI Configuration	6-4
Jukebox	6-5
Button Description	6-7

SOUND BLASTER

WINDOWS 3.0 APPLICATION

For Windows 3.0 owners, we have included a Sound Blaster application program to let you *see* and *hear* how easily Sound Blaster integrates with Windows 3.0. If you are interested in developing Windows 3.0 applications, by using *Windows SBK* (Sound Blaster Developer Kit for Windows), you can add the impact of Sound Blaster audio to your programs. We have also included a program called **SETUP** to help you put the Sound Blaster's settings in the **WIN.INI** file.

Naturally, running these programs requires Microsoft Windows 3.0 installed in your system. The programs included are:

- ▶ **Setup**
- ▶ **Jukebox**

Installation

Installation is relatively easy, however you need to follow the instructions closely. If you have any problem running these applications, check your installation.

Moving the DLL

The DLL (Dynamic-Link Library) is necessary for Windows applications. We have included the Sound Blaster DLL (**SNDBLST.DLL**). Moving the DLL to the Windows directory lets you use it with other Sound Blaster Windows applications.

To move the DLL:

1. Change to the **\SB\WINDOWS** subdirectory.
2. Copy **SNDBLST.DLL** to the **WINDOWS** directory (Normally this is in **C:\WINDOWS**).
3. Delete the **SNDBLST.DLL** file in the **\SB\WINDOWS** subdirectory.

Setting the Windows Environment

To keep your Windows neat and to make Sound Blaster programs easier to find and execute, create a program group for your Sound Blaster Windows 3.0 application.

To create the program group:

1. Select the **File** menu of Windows **Program Manager** then select **New**.
2. Select **Program Group** in the dialog box
3. Type **Sound Blaster** in the Description box and click on the **OK** button or press **Enter**. A blank window titled Sound Blaster is displayed.
4. Select **File** and **Program Item**.
5. Type **JukeBox** in the Description box and type **C:\SB\WINDOWS\JUKEBOX** in the Command Line box. You will see an icon representing JukeBox appear in the Sound Blaster Window.
6. Repeat steps four and five, except this time type **Setup** for the Description and enter **C:\SB\WINDOWS\Setup** in the Command Line. The Setup icon is displayed.

Note: These steps assume you have installed the programs in the C hard disk and in the **\SB\WINDOWS** subdirectory.

Setting the WIN.INI Configuration

The WIN.INI file, normally found in the **C:\WINDOWS** directory, contains information required by Windows to run applications correctly. To let Windows know the Sound Blaster I/O, Interrupt and DMA channel settings, they need to be placed in the WIN.INI file. Since WIN.INI is an ASCII file, you can use a word processor or text editor to add the Sound Blaster settings. The file must be stored in ASCII atext format.

However, we have made it easier for you to change the WIN.INI file by including our Windows program, **SETUP**. Using this program, you can scan the current hardware configuration, enter settings and have the program add the following defaults to the WIN.INI file:

SOUND BLASTER

[SoundBlaster]

Port=220

Int=7

DMA=1

Note: **Port** refers to the Sound Blaster I/O address; **Int** is the DAC (Digital to Analog Converter) interrupt and **DMA** is the Direct Memory Access Channel.

If you have changed the jumper settings on the Sound Blaster card, you need to change the WIN.INI file to match.

Selecting Auto Scan in SETUP lets you scan the current hardware configuration. You can also manually enter the I/O port address, interrupt and DMA channel settings. After verifying the settings, SETUP makes the necessary changes in the WIN.INI file.

To run setup:

1. Double click on the **Setup** icon in the Sound Blaster window.
2. When the dialog box appears, select Sound Blaster.
3. When the I/O port dialog box appears, the default will be selected. If it has not been changed, select OK. If the setting is not correct, a message box will appear telling you that the setting is incorrect and return you to the dialog box.
4. Make or leave the default setting on the Interrupt and DMA settings.

JukeBox

JukeBox plays MIDI files. (Files with extension .MID). This program provides a demonstration of the Sound Blaster in the Windows 3.0 environment. The program was written using the Microsoft Windows Development Kit and the Sound Blaster Developer Kit (SBK for Windows).

SOUND BLASTER

JukeBox uses the same conventions as most Windows applications. You can use the mouse, or the keyboard to make selections. You can double click with the left mouse button to select files or change directories. Without a mouse you can use the **Tab** key to move from option to option. When the desired function is highlighted, press the **Enter** key to execute this operation. You can also use the **Alt** key and the underlined character to select buttons.

The MIDI files list displays any file with the .MID extension. We have included some sample files for you to play with. The Play Queue box is where you place the MIDI files to play. The MIDI files are played in the order they appear. You can skip or remove a file at any time.

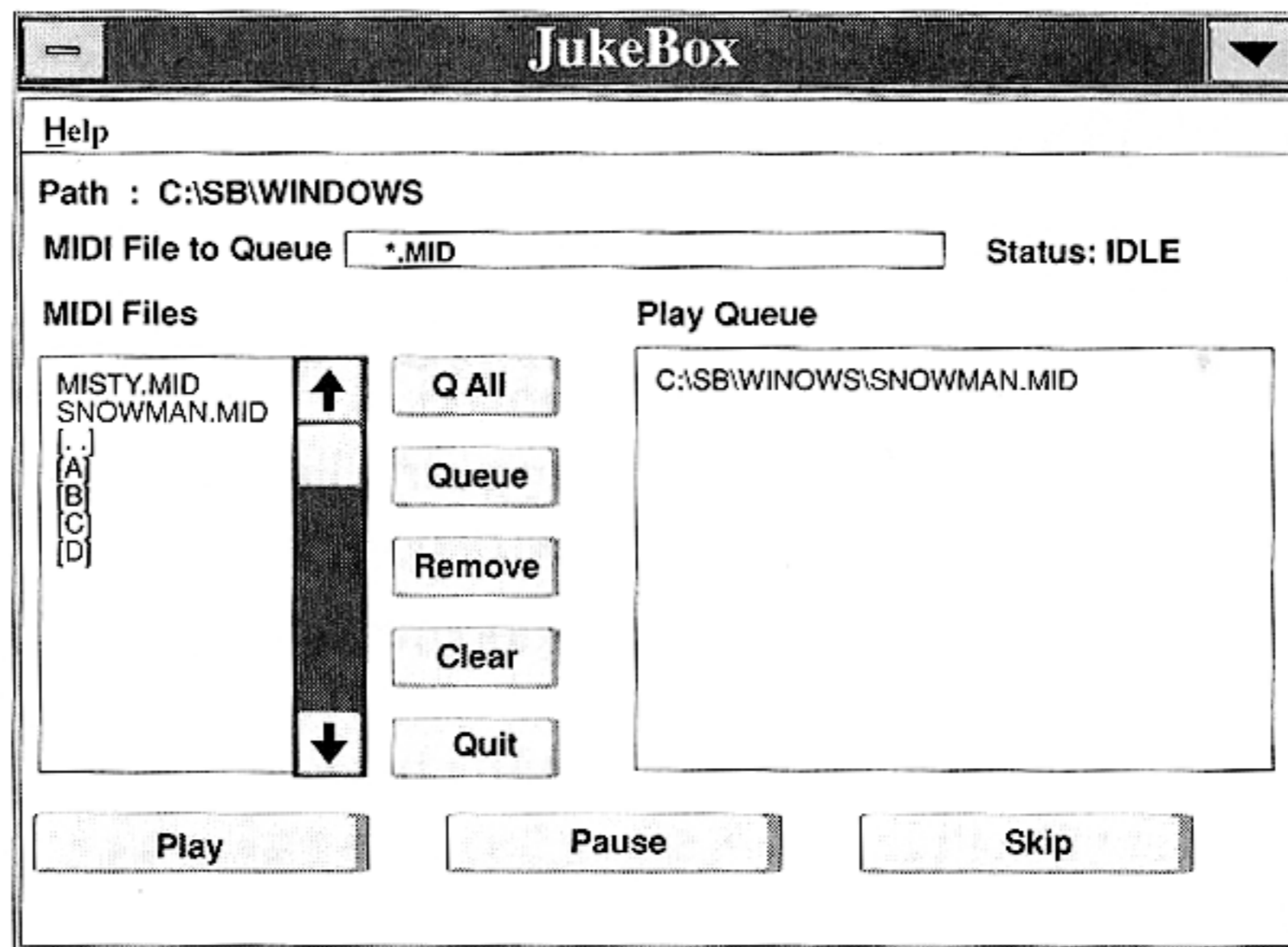

Button Descriptions

Button	Description
Q All	Pressing this button places all MIDI files in the Play Queue.
Queue	This button is used to place a selected MIDI file in the Play Queue. Select (highlight) a file and then press the Queue button. MIDI files can be placed in the Play Queue in any order. You can place a file in the Play Queue by double clicking on the file in the MIDI files box.
Remove	This removes a file from the Play Queue. Select a file in the Play Queue and press the Remove button. If a file is not selected, the first file is removed.
Clear	Press this button to clear all files from the Play Queue box.
Quit	Quits the program.
Play/Stop	This button starts and stops the JukeBox playing songs in the Play Queue. The name on the button changes to reflect the current mode. To play, a file must be in the Play Queue. When the song is finished playing, the file will disappear from the Play Queue.
Pause/ Continue	Press this button to pause the JukeBox at the current song. The button will change to say Continue. The JukeBox will remain paused until Continue button is pressed.
Skip	This skips to the next song in the Play Queue.

APPENDICES

Appendix A.....	A-3
General Specifications	A-3
Sound Capabilities	A-3
11-Voices FM Music—(AdLib compatible)	A-3
1 Digitized Voice Channel (2 x 8 bit DAC)	A-3
DAC Transfer modes	A-3
Compression schemes	A-3
Built-in stereo power amplifier	A-3
Built-in Manual Master Volume Control.	A-3
Voice Input (Digital Sampling) Capability	A-4
8 bit Stereo A-D Conversion of Sound Signal ...	A-4
ADC Transfer Modes:	A-4
Built-in Microphone	A-4
Port Output.....	A-4
Joystick Port.....	A-4
MIDI Interface	A-4
Optional C/MS 12-Voice Stereo Music	A-4
C/MS or Game Blaster Compatible Chip Kit.....	A-4

Appendices Continued

Appendix B	A-5
Hardware Data	A-5
Appendix C	A-6
Quick Reference for Problem Solving	A-6
Help for Installation	A-6
DMA Conflict	A-6
Interrupt Line (IRQ) Conflict	A-7
I/O Address Conflict	A-7
PC Interrupt and DMA Assignment Tables	A-8
Common Problems	A-9
Appendix D	A-13
Extracting compressed Files	A-13

Appendix A

General Specifications

Sound Capabilities

11-Voices FM Music—(AdLib compatible)

- ▶ Frequency Modulation sound generation for realistic sounds.
- ▶ Two modes: Nine melody sounds or six melody sound and five rhythm sounds supported by numerous games and entertainment software.

1 Digitized Voice Channel (8 bit DAC)

- ▶ Provide output of sound sampled from the real world—speech, special effects, animal sounds, thunderstorm.
- ▶ Programmable variable sampling rate 4KHz to 44.1KHz.

DAC Transfer modes

- ▶ Direct mode - direct single byte transfer by CPU.
- ▶ DMA mode - No CPU intervention/overhead required.

Compression schemes

- ▶ 8 bit data , no compression.
- ▶ 2 to 1 data compression - 4bit ADPCM, hardware decompression.
- ▶ 3 to 1 data compression - 2.6bit ADPCM, hardware decompression.
- ▶ 4 to 1 data compression - 2bit ADPCM, hardware decompression.

Built-in stereo power amplifier

- ▶ Max output : Four watts per channel, four ohms stereo output.
- ▶ Stereo headset connector drives speakers, portable speakers or headsets directly.

Built-in Manual Master Volume Control.

Voice Input (Digital Sampling) Capability

8 bit A-D Conversion of Sound Signal

- ▶ Variable sampling rate : 4KHz to 15KHz.
- ▶ ADC transfer modes: Direct mode, DMA mode with no CPU intervention required.

ADC Transfer Modes:

- ▶ Direct mode.
- ▶ DMA mode - no CPU intervention required.

Built-in Microphone and Line-In Jacks with AGC (Automatic Gain Control)

- ▶ For direct input (sampling) of sound/speech from the real world through standard microphone or from other device. (600 ohms impedance. Microphone input 0.004 to 0.7Vrms. Line-in, 39K Ohms, with a range of 0.2 to 5Vrms.

Port Output

Joystick Port

- ▶ Standard Game I/O port built-in (15 pin D-sub connector). Connects any standard IBM compatible joystick (analog).

MIDI Interface

- ▶ Built-in MIDI interface, for connection to MIDI instruments or keyboards. (Requires optional MIDI Kit.)

Optional C/MS 12-Voice Stereo Music

C/MS or Game Blaster Compatible Chip Kit

- ▶ Two optional C/MS music synthesizer chips that plug into the empty sockets on the Sound Blaster card. (Optional kit consist of two C/MS chips and one other chip.)

Appendix B

Hardware Data

The Sound Blaster uses the I/O ports addresses 220H and 240H. These are jumper selectable. Factory default is 220H. The following table list I/O addresses and functions.

I/O Address	Description	Access
2X0H	C/MS Music Voice 1-6 - data port	Write
2X1H	C/MS Music Voice 1-6 - register port	Write
2X2H	C/MS Music Voice 7-12 - data port	Write
2X3H	C/MS Music Voice 7-12 - register port	Write

I/O Address	Description	Access
2X8H	FM Music - Status Port	Read
2X8H	FM Music - Register Port	Write
2X9H	FM Music - Data Register	Write
2X6H	DSP Reset	Write
2XAH	DSP (Voice I/O & MIDI) Read Data	Read
2XCH	DSP Write Data or Command	Write
2XCH	DSP Write Buffer Status (bit 7)	Read
2XEH	DSP Data Available Status (bit 7)	Read

The above table applies only when C/MS chips are present.

Appendix C

Quick Reference for Problem Solving

Help for Installation

Read this if you have problems installing your Sound Blaster card. Also refer to **Common Problems Encountered**. When installing the Sound Blaster card, beware of possible hardware conflicts with other adaptor cards. Each adaptor card may contend for various CPU resources. There are three possible hardware conflicts sources:

- DMA channel conflict
- IRQ (Interrupt Request) lines conflict
- I/O address conflict

In the case of your Sound Blaster:

- DMA Channel 1 is the default for its digitized voice input/output DMA operations.
- The Interrupt default is set at IRQ 7 (used for voice/MIDI operations). Other jumper selections are IRQ2, IRQ3, IRQ5.
- I/O address default is 220H. Jumper selectable to 240H. FM music chip also uses addresses 388H and 389H. Joystick port uses the standard address of 200-207H.

DMA Conflict

The DMA jumper on the board either enables or disables the DMA. Removing this jumper will disable digitized voice input and output. However, FM music will continue to operate. Remove this jumper if you are operating with another adaptor card which can only use DMA channel 1. The Sound Blaster card can share a DMA channel with other adaptor cards, provided that these cards can also share DMA channels. When using Sound Blaster with other cards that have selectable DMA channels, we suggest that you change the others cards' DMA Channel to either Channel 0 or 3, if a conflict occurs. This is only feasible on an AT (286) type machines where DMA channels 0,1 and 3 are free.

If you are using an XT machine, it has only one free DMA channel, i.e. channel 1. If you have another adaptor card that uses DMA (e.g., scanner card or network card), then make sure that its DMA channel is shareable. Otherwise you have to choose between installing Sound Blaster or the other card.

Interrupt Line (IRQ) Conflict

The Sound Blaster uses interrupt line IRQ7 as default. Some printer interface (LPT1) snatch away the IRQ7 even though it never requires the interrupt.

In the rare case of interrupt conflict with another I/O card, you can change the interrupt of the Sound Blaster to IRQ2 or IRQ5.

(See **DMA and Interrupt Assignment Table** for the best IRQ line to use.)

I/O Address Conflict

The possibility of conflict on the default I/O address of 220H is very small. We advise against changing this I/O port address. Changing from this default I/O address means that you will have to reinstall software programs that support Sound Blaster. If there is a conflict with another card in you system, we suggest you change the I/O port address of the other card. Remember, to reinstall the I/O port address for programs running that card. Also set the BLASTER environment.

SOUND BLASTER

Interrupt Lines	AT Machine	XT Machine
IRQ 0	Used by System Timer	Used by System Timer
IRQ 1	Used by Keyboard	Used by Keyboard
IRQ 2	Used by System	FREE
IRQ 3	FREE (or COM Port 2)	FREE (or COM Port 2)
IRQ 4	Used by COM Port 1	Used by COM Port 1
IRQ 5	FREE	Used by Fixed Disk
IRQ 6	Used by Diskette Controller	Used by Diskette Controller
IRQ 7	FREE (Maybe LPT1)	FREE (Maybe LPT1)

DMA Channel	AT Machine	XT Machine
DMA 0	FREE	Used for RAM Refresh
DMA 1	Used by Sound Blaster	Used by Sound Blaster
DMA 2	Used by Diskette Controller	Used by Diskette Controller
DMA 3	FREE	Used by Fixed Disk

PC Interrupt and DMA Assignment Tables

Common Problems

PROBLEM	TEST-SBC error found on Interrupt.
CAUSE	Conflict on IRQ7, your system uses up IRQ7.
REMEDY	<p>Remove the Sound Blaster card from your system, and re-install its Interrupt jumper (refer "location of jumper" for more details) from IRQ7 to IRQ2 or IRQ5.</p> <p>If you have used up IRQ2 and IRQ5 for some other card, you can try to look at IRQ7 again. If it is also used up, try to look for the jumper on your system board or Parallel I/O card that allows you to disable IRQ7 for LPT1. You can consult the respective manual or your computer vendor on how to do this.</p>
PROBLEM	Voice recording too soft.
CAUSE	A device plugged into both the microphone and line-in jack. Microphone used is not sensitive enough.
REMEDY	Remove one of the devices. Use a microphone that has a 600 ohm impedance and a sensitivity of -75 dB or better for good recording. (As a rule of thumb, one that costs more than US\$30 should do the job. Remember to buy a 1/4 inch to 1/8 inch adaptor-jack if the microphone has a 1/4 inch jack. A condenser microphone also works well.
PROBLEM	Background static noise from the speakers.
CAUSE	Noisy power supply of the computer system.
REMEDY	Computer systems are well-known to be the greatest producers of electrical noise. Much care had been taken in the design of Sound Blaster's built-in amplifier to reduce as much noise from the computer's power supply as possible. There are, however, some computer systems that simply produce too much noise. This noise is picked up and amplified to an audible range when the power amplifier is set at a high volume. There is no good remedy here, except to turn down the volume control. If louder volume is desired, try to amplify using an external amplifier.

SOUND BLASTER

- PROBLEM** Noise in recording.
- CAUSE** The built-in microphone amplifier has an Automatic Gain Control (AGC) that can accept signal ranging from 0.004 to 0.7Vrms. Any input signal greater than 0.7Vrms will be clipped. This clipping will produce noise in recording. Noise can also be caused by a device connected to the microphone jack and line-in jack at the same time.
- REMEDY** Remove one device if more than one is connected. Reduce input signal level to within 0.004 to 0.7Vrms range.
- PROBLEM** "No Interrupt vector available" error when running SBFMDRV.
- CAUSE** All the DOS software interrupt vectors (INT 80H - 0BFH) are taken up by a misbehaving resident program (TSR).
- REMEDY** Most common misbehaving resident program is a DOS MENU program executed by your AUTOEXEC.BAT file. You can avoid problem with these kinds of resident programs in the following ways:
- ▶ Boot the system from a DOS diskette and then run **SBFMDRV** from the **\SB** subdirectory to confirm that the problem is solved.
 - ▶ During the booting process of the fixed disk, press **Ctrl-Break** to abort the AUTOEXEC file. Then type **SB\SBFMDRV** and press **Enter**.
 - ▶ Execute **\SB\SBFMDRV** before running the misbehaving program from your AUTOEXEC.BAT file by inserting the line **\SB\SBFMDRV** before the misbehaving program in your AUTOEXEC.BAT file. This might only solve some cases with a partially misbehaved program. With a badly misbehaved resident program, you might have to remove the command which loads the TSR program from your AUTOEXEC.BAT file.

SOUND BLASTER

- PROBLEM** Joystick port not working
- CAUSE** Sound Blaster's Joystick port conflicts with existing joystick port in the system.
- REMEDY** Take out the Sound Blaster card and remove the Joystick Enable jumper (JP8) and use the joystick port in your system instead.
- Note:** Removing JP8 will not remove the MIDI function of the card. The MIDI pins are still active on Sound Blaster's joystick port.
- PROBLEM** Joystick not working properly in some programs.
- CAUSE** This is a classic problem with PC's joystick port which uses the CPU timing to calculate joystick position. When a CPU is too fast and the program does not take good care of the change in CPU speed, the wrong calculation would cause the joystick port to move to its unusable range.
- The Sound Blaster adheres to this PC standard and hence would inherit the same problems. You could confirm that the joystick port is working if some programs can handle the joystick properly.
- REMEDY** A possible remedy here is to switch the computer to its lowest possible speed.
- PROBLEM** Sound Blaster MIDI port not compatible to Roland MPU 401.
- CAUSE** The Sound Blaster complies with the International MIDI Association recommended standard. The MPU 401 has some intelligence in its MIDI implementation. This intelligence could be easily emulated by a small driver routine in the PC. Hence, programs that run on the MPU 401 cannot work directly on the Sound Blaster. They must be modified by their respective software companies in order to run on the Sound Blaster.
- Before buying any MIDI software, please ensure that they support Sound Blaster.

SOUND BLASTER

- PROBLEM** Computer hangs after running one of the Sound Blaster program.
- CAUSE** Conflict with other adaptor cards in the system.
- REMEDY** To identify the possible conflicting card, remove all the non-essential cards one by one from the system; leaving only the essential cards : Diskette/Fixed Disk Controller Card and Video Adaptor Card in the system.
- After each card is removed, run the same program that hangs the system. If the problem is solved, then the last card removed has a possible conflict with Sound Blaster. Try to determine whether it is a DMA conflict, Interrupt conflict or I/O address conflict by looking in the manual of this card.
-
- PROBLEM** Talking Parrot talks with a very low voice and slow voice.
- CAUSE** Running the Talking Parrot on an XT machine.
- REMEDY** The Talking Parrot need an AT (286) machine to work properly. If you are using an XT, you will have to do away with this demonstration program.

Appendix D

Extracting Compressed Files

To extract individual files from the compressed files on the Sound Blaster diskettes, use the CLZX program found in Disk #1. Compressed files have the .CLZ extension. This program can come in handy if you do not have a hard disk and want to extract files to a floppy drive.

Entry format to extract files:

CLZX clzfile [options] [destpath files..]

Or to view a list of the files in a .CLZ file enter:

CLZX clzfile /L

where

- ▶ **clzfile** is the name of the compressed file that contains the file(s) you want to extract.
- ▶ **destpath** is the destination directory where you wish to place extracted files.
- ▶ **files** are the names of the files you want to extract. You can list several files on the command line. Separate the file names with a blank space. You can also use DOS wildcard characters ? and * to specify multiple files.
- ▶ **options** are one of the following:
 - /q - suppresses all messages during the decompression.
 - /h or /? - displays a reminder of how to run the program.
 - /b - makes back-up copies of existing files before extracting your

files. These backup files have the extension **B~K**, instead of the usual .BAK extension. The default is no backups and overwrites existing files.

Some examples are in order. Let's assume you have copied the **CLZX.COM** program and the file FMORGAN.CLZ (found in diskette #1) into your current directory. To see what files are in **FMORGAN.CLZ** file, type:

```
CLZX FMORGAN.CLZ /I
```

To extract the files **AIR.ORG**, **CHACONNE.ORG** and **FMORGAN.EXE** into the current directory, type:

```
CLZX FMORGAN.CLZ . AIR.ORG CHACONNE.ORG  
FMORGAN.EXE
```

Note: Periods indicate current directory and must be entered

To extract all the organ files starting with the letters **C** and **G**, and to make backup copies of any existing file, type:

```
CLZX FMORGAN.CLZ /B . C*.ORG G*.ORG
```

Let's say you have created a subdirectory called **ORGFILES** in your current directory. To extract all the organ files and place them in the **ORGFILES** subdirectory, type:

```
CLZX FMORGAN.CLZ ORGFILES *.ORG
```

And, finally, to place all files contained in the compressed file in the directory **D:\SB\FMORGAN**, type:

```
CLZX FMORGAN.CLZ D:\SB\FMORGAN *.*
```

NOTES

NOTES

SOUND BLASTER

SPEECH/MUSIC/VOICE/MIDI/GAME PORT

THE ULTIMATE SOUND BOARD FOR YOUR PC

Design by Creative Labs, Inc.

Printed in Singapore